

ARTESYN

BCQ1300-48S12B-4L

1300 Watts Quarter Brick Converter



PRODUCT DESCRIPTION

Advanced Energy's Artesyn BCQ1300-48S12B-4L is a single output DC-DC converter with standard quarter-brick outline and pin configuration. It delivers up to 90A output current with 9.6V~14.5V output voltage. Ultra-high 97.7% efficiency and excellent thermal performance makes it an ideal choice for use in datacom and telecommunication applications and can work under -40 °C ~ +85 °C with air cooling.

TECHNICAL REFERENCE NOTE

Total Power:

1300 Watts

Input Voltage:

40-60 Vdc

of Outputs:

Single



SPECIAL FEATURES

- Delivering up to 90A output
- Ultra-high efficiency 97.7% typ. at 50% load
- Startup Pre-bias:0%Vout ~ 8V
- Input range: 40V ~ 60V
- Excellent thermal performance
- No minimum load requirement
- RoHS 6 compliant
- Remote control function
- Input under voltage lockout
- Input over voltage lockout
- Parallel current sharing
- Output over current protection
- Over temperature protection
- Industry standard quarter-brick pin-out outline
- Baseplated
- Pin length option: 4.6mm

SAFETY

- IEC/EN/UL/CSA 60950 2nd
- 2006/95/EEC CE Mark
- GB4943
- UL/TUV
- UL94,V-0
- FCC/EN55022 Class A

TYPICAL APPLICATIONS

- Telecom
- Datacom

Model Numbers

Standard	Output Voltage	Structure	Remote ON/OFF logic	ROHS
BCQ1300-48S12B-4L	9.6Vdc~14.5Vdc	Baseplated	Negative	R6

Order Information

BCQ1300	-	48	S	12	P	B	-	4	L
①		②	③	④	⑤	⑥		⑦	⑧

①	Model series	BCQ: High efficiency quarter brick series, 1300: output power 1300W
②	Input voltage	48: 40V ~ 60V input range, rated input voltage: 53V
③	Output number	S: single output
④	Rated output voltage	12: 12V output
⑤	Remote ON/OFF logic	Default: negative logic; P: positive logic
⑥	Baseplate	B: with baseplate; default: open frame
⑦	Pin length	4: 4.6mm ± 0.25mm pin length
⑧	RoHS status	Y: Rohs, R5; L: RoHS, R6

Options

None

Electrical Specifications

Absolute Maximum Ratings

Stress in excess of those listed in the “Absolute Maximum Ratings” may cause permanent damage to the power supply. These are stress ratings only and functional operation of the unit is not implied at these or any other conditions above those given in the operational sections of this TRN. Exposure to any absolute maximum rated condition for extended periods may adversely affect the power supply’s reliability.

Table 1. Absolute Maximum Ratings							
Parameter		Model	Symbol	Min	Typ	Max	Unit
Input Voltage	Operating -Continuous	All modules	$V_{IN,DC}$	-	-	60	Vdc
	Non-operating -100mS			-	-	75	Vdc
Maximum Output Power ¹		All modules	$P_{O,max}$	-	-	1300	W
Isolation Voltage ²		All modules		-	-	1500	Vdc
	Input to outputs						
Ambient Operating Temperature		All modules	T_A	-40	-	+85	°C
Storage Temperature		All modules	T_{STG}	-55	-	+125	°C
Voltage at remote ON/OFF pin		All modules		-0.3	-	15	Vdc
Humidity (non-condensing)		All modules		-	-	95	%
	Operating						

Note 1 - Maximum power delivery happens at maximum input voltage. The maximum output power tends to decline when input voltage drops. The Maximum power at minimum input voltage is 864W

Note 2 - 1mA for 60s,slew rate of 1500V/10S

Electrical Specifications

Input Specifications

Table 2. Input Specifications							
Parameter	Conditions ¹	Symbol	Min	Typ	Max	Unit	
Operating Input Voltage, DC	All	$V_{IN,DC}$	40	53	60	Vdc	
Input under-voltage lockout	Turn-on Voltage Threshold	$I_O = I_{O,max}$	$V_{IN,ON}$	35.5	38	40	Vdc
	Turn-off Voltage Threshold	$I_O = I_{O,max}$	$V_{IN,OFF}$	34.5	36	39	Vdc
	Lockout Voltage Hysteresis	$I_O = I_{O,max}$		1	-	3	Vdc
Input over voltage lockout	Turn-on Voltage Threshold	$I_O = I_{O,max}$	$V_{IN,ON}$	60	62	65	Vdc
	Turn-off Voltage Threshold	$I_O = I_{O,max}$	$V_{IN,OFF}$	61	64	66	Vdc
	Lockout Voltage Hysteresis	$I_O = I_{O,max}$		1	-	3	Vdc
Maximum Input Current ($I_O = I_{O,max}$)		$I_{IN,max}$	-	-	25	A	
No Load Input Current	$V_{IN,DC} = 53Vdc$	I_{IN}	-	150	-	mA	
Standby Input Current	Remote Off	I_{IN}	-	2	-	mA	
Recommended Input Fuse	Fast blow external fuse recommended		-	-	30	A	
Recommended External Input Capacitance	Low ESR capacitor recommended	C_{IN}	470	-	-	uF	
Input Ripple Current	Through 12uH inductor		-	70	-	mA	
Input Filter Component Value(C\L)	Internal values		-	28.2\0.15	-	uF\muH	
Operating Efficiency	$T_A = 25\text{ }^\circ\text{C}$ Vin=53Vdc Airflow = 1000LFM $I_O = I_{O,max}$ $I_O = 70\%I_{O,max}$	η	-	97.6 97.7	-	% %	

Note 1 - $T_A = 25\text{ }^\circ\text{C}$, airflow rate = 400 LFM, Vin = 48Vdc, nominal Vout unless otherwise noted.

Electrical Specifications

Output Specifications

Table 3. Output Specifications							
Parameter	Conditions ¹	Symbol	Min	Typ	Max	Unit	
Factory Set Voltage	$V_{IN,DC} = 53Vdc$ $I_O = I_{O,min}$	V_O	13.00	13.13	13.26	Vdc	
Output Voltage Line Regulation	All	$\pm V_O$	-	-	-	mV	
Output Voltage Load Regulation	All	$\pm V_O$	-	-	400	mV	
Output Voltage Temperature Regulation	All	$\%V_O$	-	-	0.02	$\%/^{\circ}C$	
Output Ripple, pk-pk	20MHz bandwidth	V_O	-	180	-	mV_{PK-PK}	
Output Current	All	I_O	0	-	90	A	
Output DC current-limit inception ²		I_O	95	-	140	A	
V_O Load Capacitance	All	C_O	470	-	6000	μF	
V_O Dynamic Response	Peak Deviation Settling Time	25%~50%, 50%~75% $I_{O,max}$ slew rate = 0.1A/us	$\pm V_O$ T_s	- -	200 400	- -	mV uSec
		25%~50%, 50%~75% $I_{O,max}$ slew rate = 1A/us	$\pm V_O$ T_s	- -	200 400	- -	mV uSec
Turn-on transient	Rise time	$I_O = I_{O,max}$	T_{rise}	-	20	50	mS
	Turn-on delay time	$I_O = I_{O,max}$	$T_{turn-on}$	-	20	50	mS
	Turn-On overshoot	$I_O = 0$		-	-	5	$\%V_O$
Remote ON/OFF control (negative logic)	Off-state voltage			2.4		15	Vdc
	On-state voltage			-0.3		0.8	Vdc
Pre-bias		V_O	0	-	8	V	
Output over-temperature protection ³	All	T	100	-	130	$^{\circ}C$	
Over-temperature hysteresis	All	T	-	-	-	$^{\circ}C$	

Note 1 - $T_A = 25^{\circ}C$, airflow rate = 400 LFM, $V_{in} = 53Vdc$, nominal V_{out} unless otherwise noted.

Note 2 - Hiccup: auto-restart when over-current condition is removed.

Note 3 - Auto recovery; over-temperature protect(OTP) test point, See Figure 11 P1 test point.

Electrical Specifications

BCQ1300-48S12B-4L Performance Curves

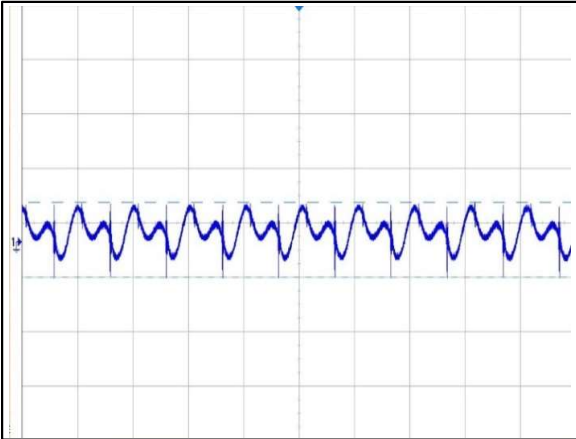

Figure 1: BCQ1300-48S12B-4L Input reflected ripple current waveform
Ch 1: Vin (10us/div, 50mA/div)

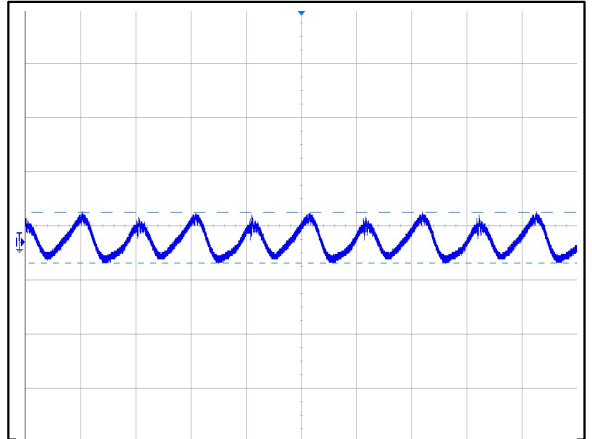

Figure 2: BCQ1300-48S12B-4L Ripple and Noise Measurement
Ch 1: Vo (5uS/div, 200mV/div)

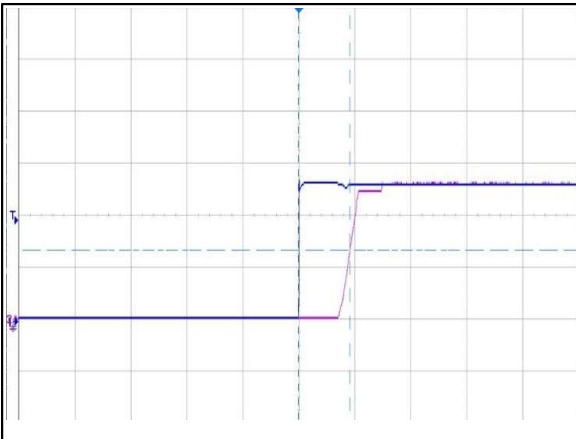

Figure 3: BCQ1300-48S12B-4L Output voltage Startup by Power On (20ms/div)
Ch 1: Vin (20V/div) Ch 2: Vo (5V/div)

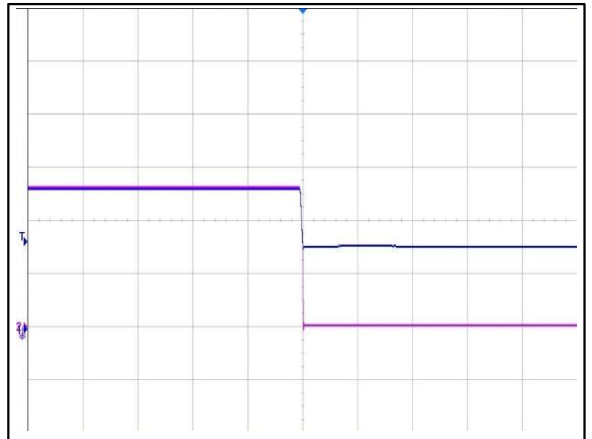

Figure 4: BCQ1300-48S12B-4L Output voltage Shutdown by Power Off (10ms/div)
Ch 1: Vin (20V/div) Ch 2: Vo (5V/div)

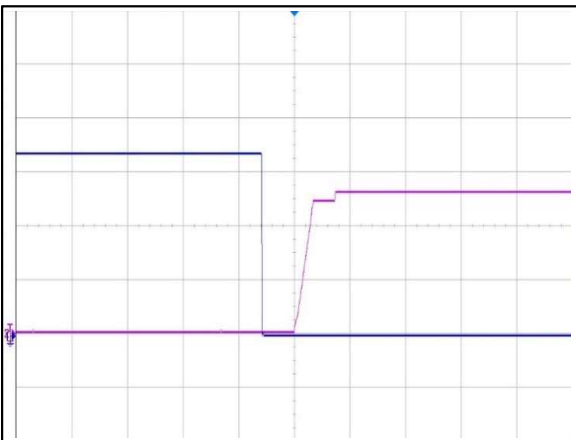

Figure 5: BCQ1300-48S12B-4L Output Startup by Remote On (20ms/div)
Ch 1: Remote ON (1V/div) Ch 2: Vo (5V/div)

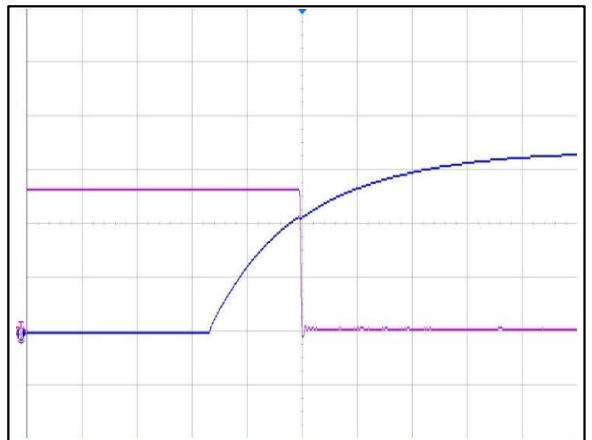

Figure 6: BCQ1300-48S12B-4L Output voltage Shutdown by Remote Off (5mS/div)
Ch 1: Remote OFF (1V/div) Ch 2: Vo (5V/div)

Electrical Specifications

BCQ1300-48S12B-4L Performance Curves

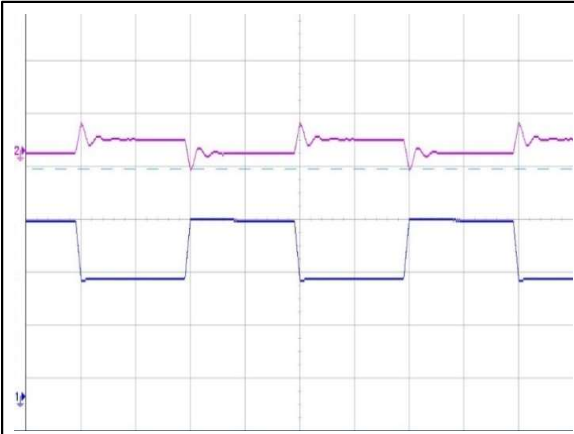

Figure 7: BCQ1300-48S12B-4L Transient Response (2mS/div)
 25% load step(50%-75%-50%), 0.1A/ μ s slew rate
 Ch 1: Io (20A/div) Ch 2: Vo (500mV/div)

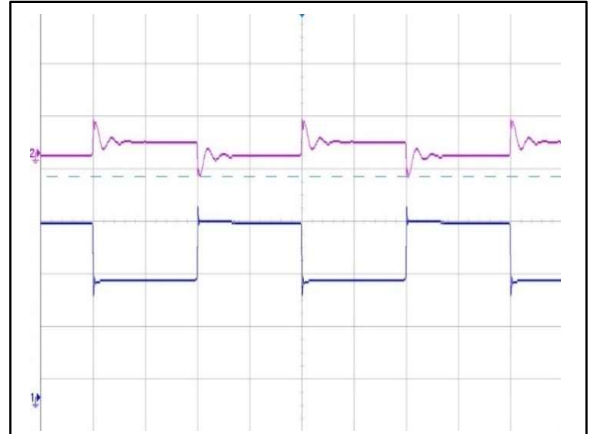

Figure 8: BCQ1300-48S12B-4L Transient Response (2mS/div)
 50% load step(50%-75%-50%), 1A/ μ s slew rate
 Ch 1: Io (20A/div) Ch 2: Vo (500mV/div)

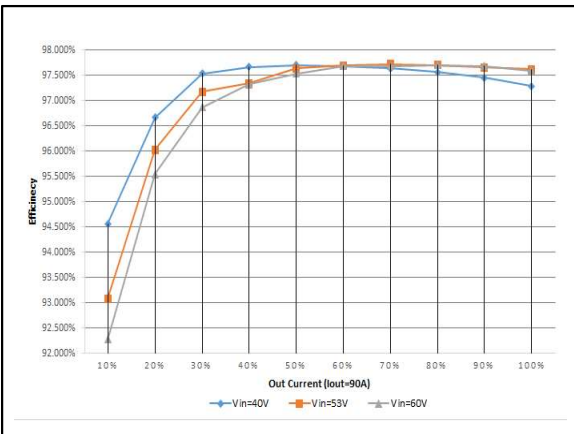

Figure 9: BCQ1300-48S12B-4L Efficiency Curves $T_a = 25^\circ\text{C}$
 Loading: Io = 10% increment to 90A

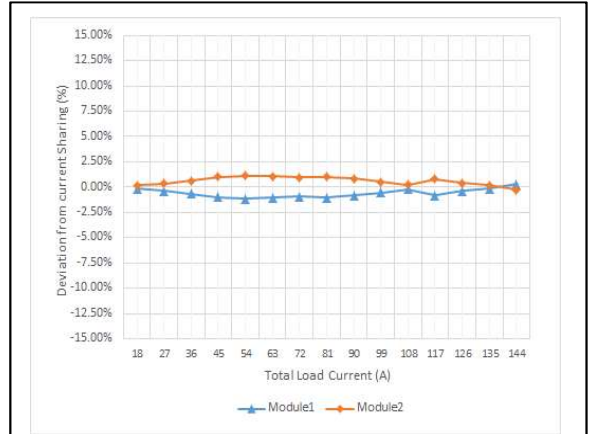

Figure 10: BCQ1300-48S12B-4L Current share performance of 2 paralleled modules

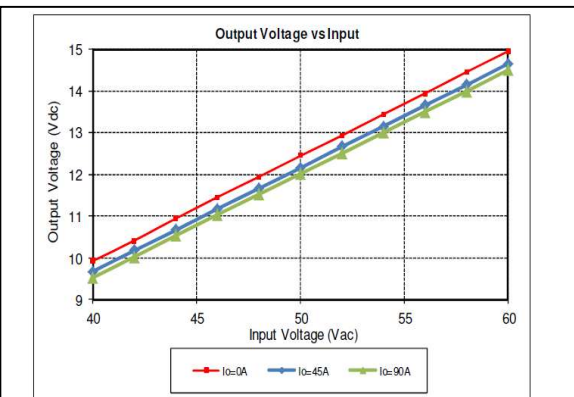
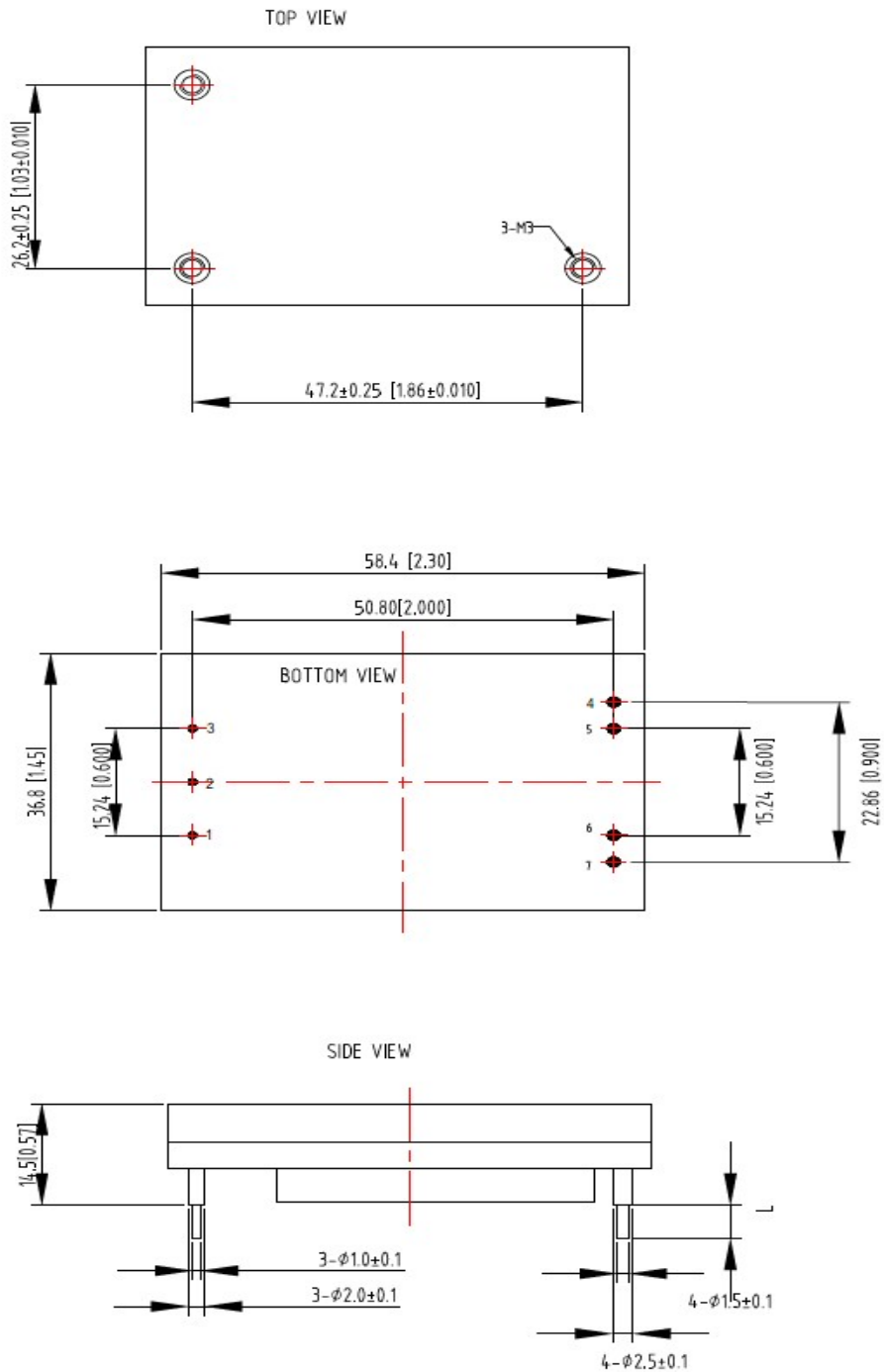

Figure 11: BCQ1300-48S12B-4L Output Characteristic Vout vs Vin

Mechanical Specifications

Mechanical Outlines – Baseplate Module



Unit: mm[inch] Bottom view: pin on upside
 Tolerance: X.Xmm ± 0.5mm [X.X in. ± 0.02in.]
 X.XXmm ± 0.25mm [X.XX in. ± 0.01in.]

Mechanical Specifications

Pin length option

Device code suffix	L
-4	4.6mm ± 0.25mm
-6	3.8mm ± 0.25mm
-8	2.8mm ± 0.25mm
None	5.8mm ± 0.25mm

Pin Designations

Pin No	Name	Function
1	Vin+	Positive input voltage
2	Remote ON/OFF	Remote control
3	Vin-	Negative input voltage
4 & 5	Vo-	Negative output voltage
6 & 7	Vo+	Positive output voltage

Environmental Specifications

EMC Immunity:

BCQ1300-48S12B-4L power supply is designed to meet the following EMC immunity specifications:

Table 4. Environmental Specifications		
Document	Description	Criteria
EN55032, Class B Limits	Conducted Emission Limits, DC input port	/
IEC/EN 61000-4-2, Level 3	Electromagnetic Compatibility (EMC) - Testing and measurement techniques: Electrostatic discharge immunity test	B
IEC/EN 61000-4-4, Level3	Electromagnetic Compatibility (EMC) - Testing and measurement techniques: Electrical Fast Transient. DC input port.	B
IEC/EN 61000-4-5	Electromagnetic Compatibility (EMC) - Testing and measurement techniques: Immunity to surges - 600V common mode and 600V differential mode for DC port	B
IEC/EN 61000-4-6, Level 2	Electromagnetic Compatibility (EMC) - Testing and measurement techniques: Continuous Conducted Interference. DC input port	A
EN61000-4-29	Electromagnetic Compatibility (EMC) - Testing and measurement techniques: Voltage Dips and short interruptions and voltage variations. DC input port	B

Criterion A: Normal performance during and after test.

Criterion B: For EFT and surges, low-voltage protection or reset is not allowed. Temporary output voltage fluctuation ceases after disturbances ceases, and from which the EUT recovers its normal performance automatically. For Dips and ESD, output voltage fluctuation or reset is allowed during the test, but recovers to its normal performance automatically after the disturbance ceases.

Criterion C: Temporary loss of output, the correction of which requires operator intervention.

Criterion D: Loss of output which is not recoverable, owing to damage to hardware

Recommended EMC Filter Configuration

See Figure22

Environmental Specifications

Safety Certifications

The BCQ1300-48S12B-4L power supply is intended for inclusion in other equipment and the installer must ensure that it is in compliance with all the requirements of the end application. This product is only for inclusion by professional installers within other equipment and must not be operated as a stand alone product

Table 5. Safety Certifications for BCQ1300-48S12B-4L series module		
Standard	Agency	Description
UL/CSA 62368-1		US and Canada Requirements
EN62368-1		European Requirements
IEC62368-1		International Requirements
CE		CE Marking
UL94		Materials meet V-0 flammability rating
TUV		International Requirements

Environmental Specifications

Operating Temperature

The BCQ1300-48S12B-4L power supply will start and operate within stated specifications at an ambient temperature from -40 °C to 85 °C under all load conditions. The storage temperature is -55 °C to 85 °C.

Thermal Considerations – Baseplate module (BCQ1300-48S12B-4L)

The converter is designed to operate in different thermal environments and sufficient cooling must be provided. Proper cooling can be verified by measuring the temperature at the test points as shown in the figure 11. The temperature at these points should not exceed the max values in below table 6.

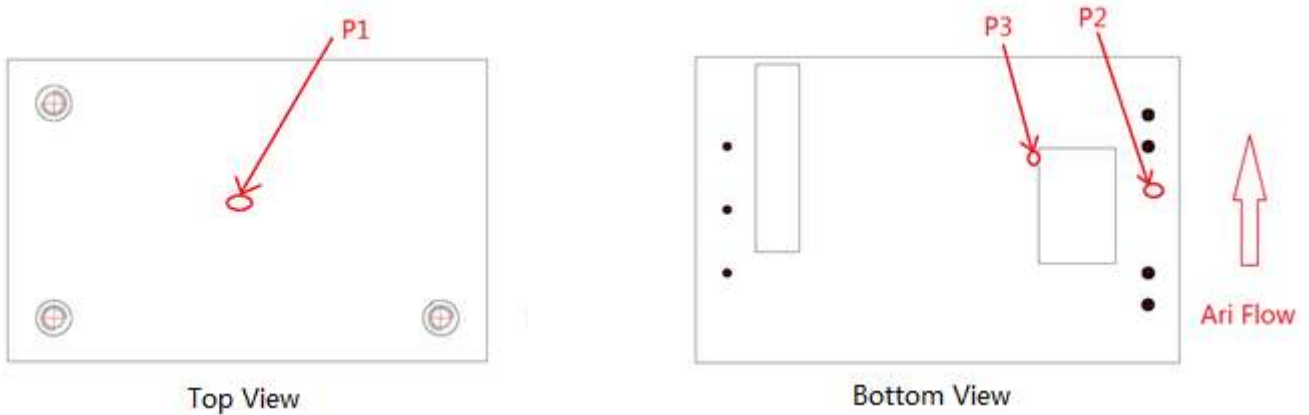

Figure 12 Temperature test point

Table 6. Temperature Limit of the test point	
Test Point	Temperature limit
P1	106 °C
P2	110 °C
P3	117 °C

Environmental Specifications

Base plate without heatsink unit Thermal Derating data

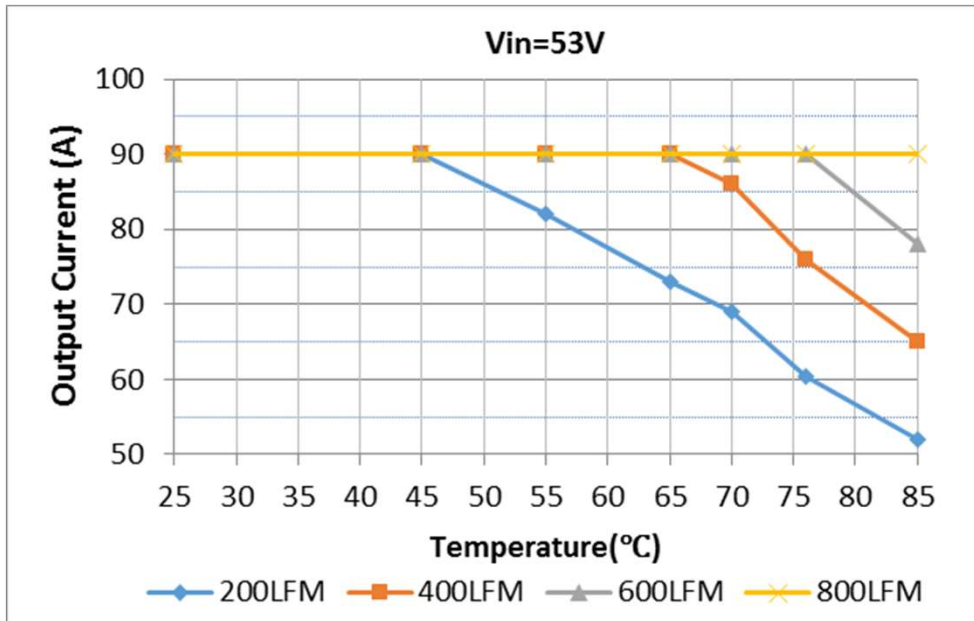

Figure 13 Output power derating, 53Vin, air flowing across the converter from Vin- to Vin+

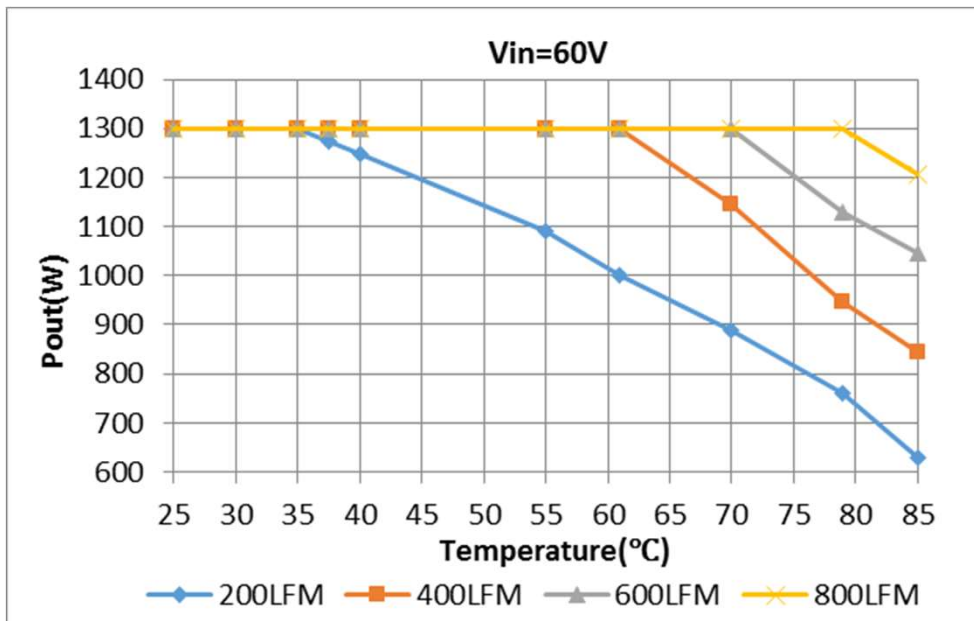

Figure 14 Output power derating, 60Vin, air flowing across the converter from Vin- to Vin+

Environmental Specifications

Thermal Considerations - Base plate Module (BCQ1300-48S12B-4L)

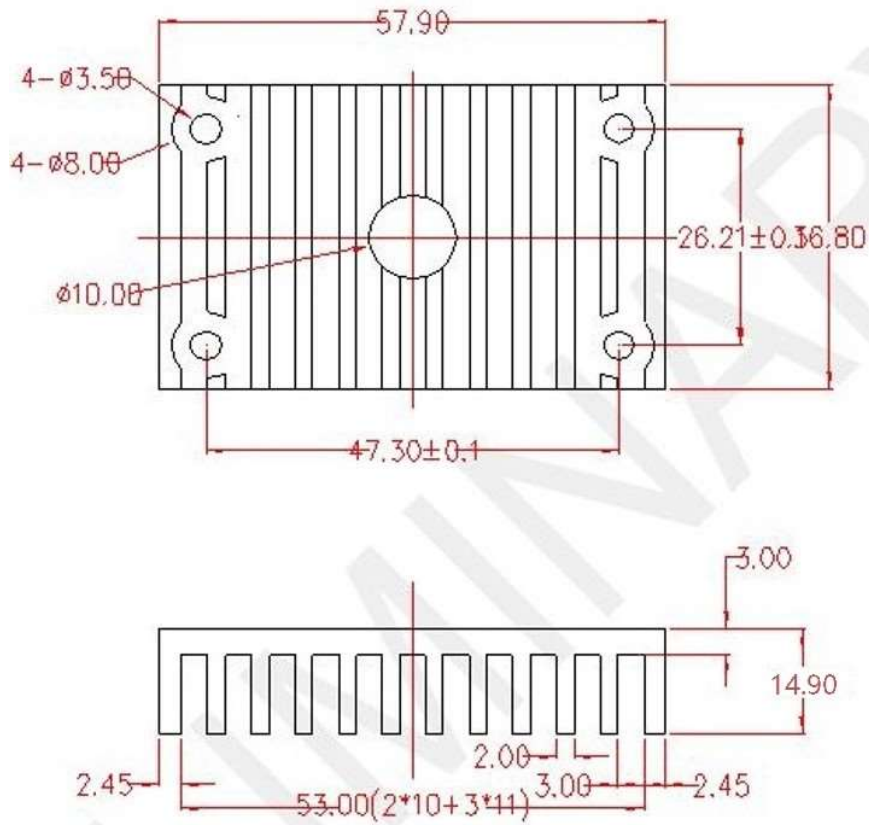

Figure 15 Typical test condition, heatsink

Baseplate with heatsink unit Thermal Derating data



Figure 16 Typical test condition, heatsink

Environmental Specifications

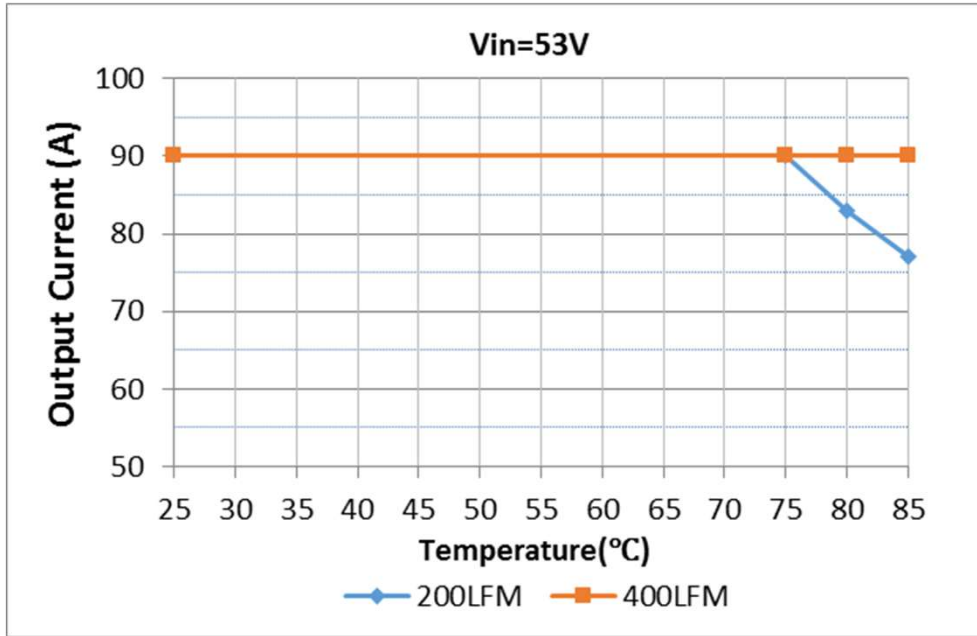

Figure 17 Output power derating, 53V_{in}, air flowing across the converter from Vin- to Vin+

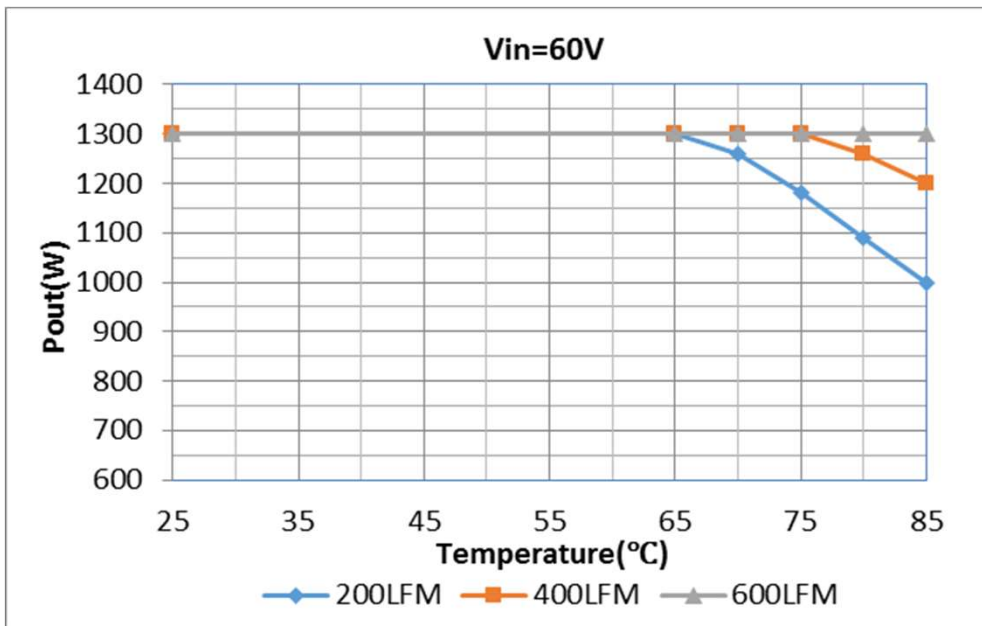

Figure 18 Output power derating, 60V_{in}, air flowing across the converter from Vin- to Vin

Environmental Specifications

Table 7. Qualification Testing

Parameter	Unit (pcs)	Test condition
HALT test	2	Operating limit: Ta,min-20 °C to Ta,max+100 °C, 10 °C step, Vin = min to max, 0 ~ 100% load Vibration Limit: >30g.
Vibration	2	Frequency range: 5Hz ~ 20Hz, 20Hz ~ 200Hz, A.S.D: 1.0m2/s3, -3db/oct, axes of vibration: X/Y/Z. Time: 30min/axis, non operational
Mechanical Shock	2	Type: half sine, Acceleration: 30g, Duration: 6ms, Directions:6, Number of shock: 3times/face. Non Operational
Thermal Shock	3	-55 °C to 125 °C, Temp Dwell Time:30min, Temp change rate: 20 °C/min, Unit temperature 20cycles
Thermal Cycling	3	-40 °C to 85 °C, temperature change rate: 1 °C/min, cycles: 2cycles
Humidity	3	40 °C, 95%RH, 48h
MTBF		Telcordia, SR332 Method 1 Case 1; 1.5Mhrs Typically

Application Notes

Typical Application

Below is the typical application of the BCQ1300-48S12B-4L series power supply.

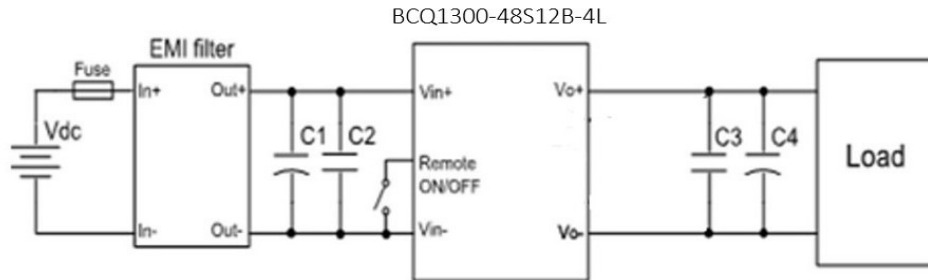

Figure 19 Typical application

C1: 470 μ F/100V electrolytic capacitor, P/N: Nichicon

C2: 1 μ F/100V X7R ceramic capacitor, P/N: TDK

C3: 4*10 μ F/25V X7R ceramic capacitor, P/N: TDK

C4: 560 μ F/25V electrolytic capacitor, P/N: Oscon

Note: If ambient temperature is below -5 $^{\circ}$ C, double output capacitor (Low ESR, $ESR \leq 100m\Omega$) is needed for output.

Fuse: External fast blow fuse with a rating of 30A/250Vac. The recommended fuse model is 0314030 MRP from Karwin Tech limited.

EMI filter: refer to Figure 22

Application Notes

Remote ON/OFF

Negative remote ON/OFF logic is available in BCQ1300-48S12B-4L. The logic is CMOS and TTL compatible.

Below is the detailed internal circuit and reference in BCQ1300-48S12B-4L.

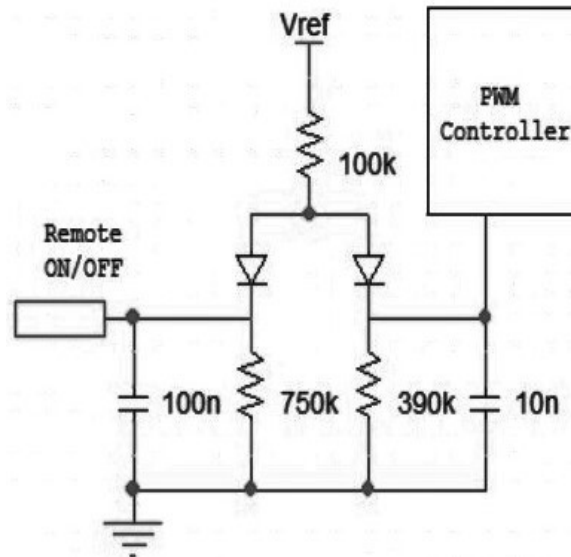

Figure 20 Remote ON/OFF internal diagram

Application Notes

Input Ripple, Output Ripple & Noise Test Configuration

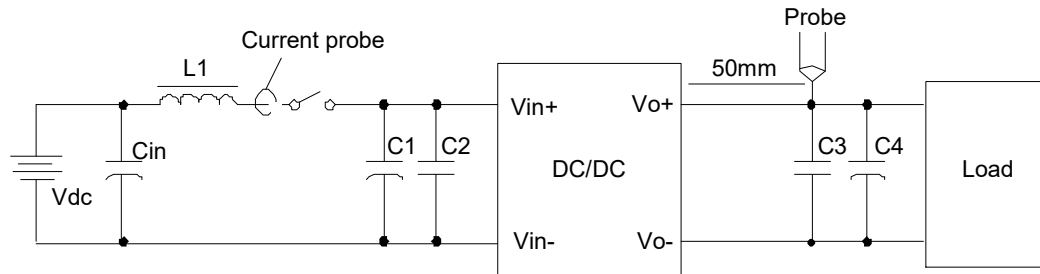

Figure 21 Input ripple, inrush current output ripple & noise test configuration

Vdc: DC power supply

L1: 12 μ H

Cin: 220 μ F/100V typical

C1 ~ C4: See Figure 16

Note: Using a coaxial cable with series 50 Ω resistor and 0.68 μ F ceramic capacitor or a ground ring of probe to test output ripple & noise is recommended.

Application Notes

EMC Test Conditions

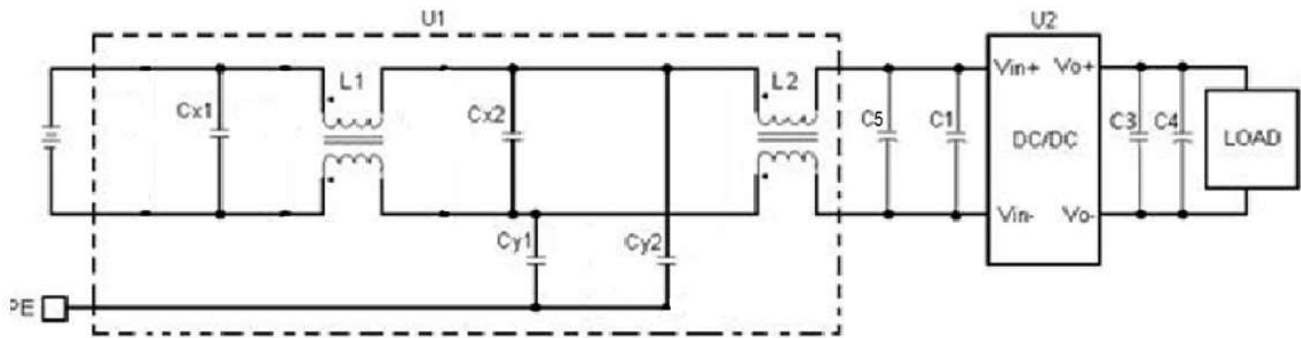

Figure 22 EMC Test Conditions

- U1: Input EMC filter
- U2: Module to test, BCQ1300-48S12B-4L
- Cx1: 7*SMD ceramic-100V/4.7uF/X7R capacitor
- Cx2: 4*SMD ceramic-100V/4.7uF/X7R capacitor
- Cy1, Cy2: SMD ceramic-630V/0.22uF/X7R Y capacitor
- C1: 470μF/100V electrolytic capacitor, P/N: Nichicon
- C3: SMD ceramic- 10uF/25V/X7R capacitor
- C4: 1000uF/25V/ electrolytic capacitor, P/N: Oscon or POSCAP
- C5: SMD ceramic- 0.1uF/100V/X7R capacitor
- L1: 650uH, common mode inductor
- L2: 650uH, common mode inductor

Figure 20 Trim up curve at full power

Application Notes

Parallel Current Sharing

The module is capable of operating in parallel.

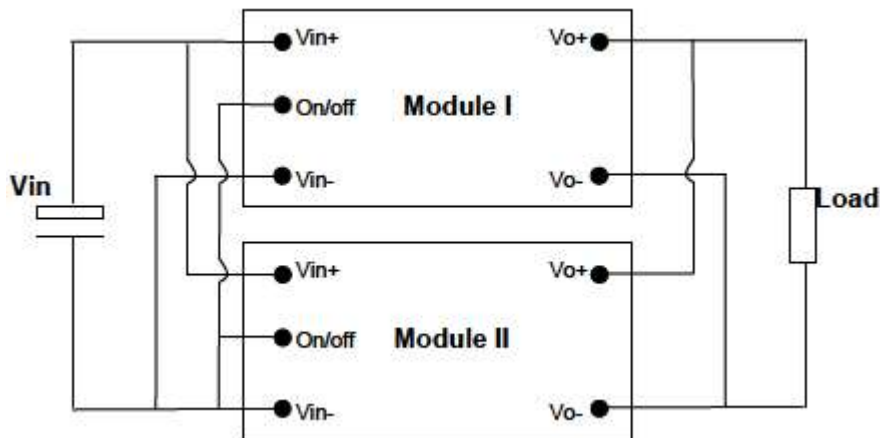

Figure 23 Parallel current sharing configuration for no redundancy requirement system

If system has no redundancy requirement, the module can be parallel directly for higher power without adding external oring-fet; whereas, if the redundancy function is required, the external oring-fet should be added.

For a normal parallel operation the following precautions must be observed:

1. The current sharing accuracy equation is:

$$X\% = \left| I_o - \left(I_{total} / N \right) \right| / I_{rated}$$

Where, I_o is the output current of per module; I_{total} is the total load current; N is parallel module numbers; I_{rated} is the rated full load current of per module.

2. To ensure a better steady current sharing accuracy, below design guideline should be followed:

- The inputs of the converters must be connected to the same voltage source; and the PCB trace resistance from Input voltage source to V_{in+} and V_{in-} of each converter should be equalized as much as possible.
- The PCB trace resistance from each converter's output to the load should be equalized as much as possible.
- For accurate current sharing accuracy test, the module should be soldered in order to avoid the unbalance of the touch resistance between the modules to the test board.

3. To ensure the parallel module can start up monotonically without triggering the OCP circuit, below design guideline should be followed:

- Before all of the parallel modules finished start up, the total load current should be lower than the rated current of 1 module.
 - The ON/OFF pin of the converters should be connected together to keep the parallel modules start up at the same time.
 - The under voltage lockout point will slightly vary from unit to unit. The dv/dt of the rising edge of the input source voltage must be greater than 1V/ms to ensure that the parallel module start up at the same time.
4. If fault tolerance is desired in parallel applications, output ORing devices should be used to prevent a single module failure from collapsing the load bus

Application Notes

Soldering

The BCQ1300-48S12B-4L is intended for standard manual or wave soldering.

When wave soldering is used, the temperature on pins is specified to maximum 255 °C for maximum 7s.

When soldering by hand, the iron temperature should be maintained at 300 °C ~ 380 °C and applied to the converter pins for less than 10s. Longer exposure can cause internal damage to the converter.

Cleaning of solder joint can be performed with cleaning solvent IPA or simulative.

Application Notes

Hazardous Substances Announcement (RoHS China)

Parts	Hazardous Substances					
	Pb	Hg	Cd	Cr ⁶⁺	PBB	PBDE
BCQ1300-48S12XX-4L	x	x	x	x	x	x
<p>x: Means the content of the hazardous substances in all the average quality materials of the part is within the limits specified in SJ/T-11363-2006</p> <p>v: Means the content of the hazardous substances in at least one of the average quality materials of the part is outside the limits specified in SJ/T11363-2006</p> <p>Artesyn Embedded Technologies has been committed to the design and manufacturing of environment-friendly products. It will reduce and eventually eliminate the hazardous substances in the products through unremitting efforts in research. However, limited by the current technical level, the following parts still contain hazardous substances due to the lack of reliable substitute or mature solution:</p> <ol style="list-style-type: none"> 1. Solders (including high-temperature solder in parts) contain plumbum. 2. Glass of electric parts contains plumbum. 3. Copper alloy of pins contains plumbum 						

Record of Revision and Changes

Issue	Date	Description	Originators
1.0	06.10.2019	First Issue	K. Wang
1.1	06.10.2020	Add the Vout Vs Vin Curve	K..Wang



For international contact information,
visit advancedenergy.com.

powersales@aei.com (Sales Support)
productsupport.ep@aei.com (Technical Support)
+1 888 412 7832

ABOUT ADVANCED ENERGY

Advanced Energy (AE) has devoted more than three decades to perfecting power for its global customers. AE designs and manufactures highly engineered, precision power conversion, measurement and control solutions for mission-critical applications and processes.

Our products enable customer innovation in complex applications for a wide range of industries including semiconductor equipment, industrial, manufacturing, telecommunications, data center computing, and medical. With deep applications know-how and responsive service and support across the globe, we build collaborative partnerships to meet rapid technological developments, propel growth for our customers, and innovate the future of power.

PRECISION | POWER | PERFORMANCE

Specifications are subject to change without notice. Not responsible for errors or omissions. ©2020 Advanced Energy Industries, Inc. All rights reserved. Advanced Energy®, and AE® are U.S. trademarks of Advanced Energy Industries, Inc.

Rev.06.10.20_#1.1