

ARTESYN μ MP SERIES GEN II

Up to 1800 Watts with New Product Enhancements



Advanced Energy's Artesyn μ MP series GEN II power supply is a configurable power supply with market-leading density and efficiency. It features a very wide 85 to 264 VAC input voltage range and employs active power factor correction to minimize input harmonic current distortion and to ensure compliance with the international EN61000-3-2 standard – they have a power factor of 0.99 typical. The power supplies also feature active AC inrush control to automatically limit inrush current at turn-on to 40 A maximum.

SPECIAL FEATURES

- Full Medical EN60601 approval
- PMBus monitor/control of input functions
- High efficiency
- Constant current limit protection
- High power density.
 - μ MP04: 10.8 W/cu-in
 - μ MP09: 19.8 W/cu-in
 - μ MP10: 15.1 W/cu-in
 - μ MP16: 22.7 W/cu-in
- Low noise intelligent fan (speed control/fault status), 36% reduction from GEN I
- Downloadable GUI from website
- Optional conformal coating
- Industrial temp range (-40 to 70°C)
- No preload required
- Military STD Shock (40G) / Vibration (> 4gRMS)
- Low cost

- IEC, terminal block or barrier strip input connection options
- Low profile 1U size
- Superior aesthetics over GEN I

CERTIFICATIONS

- UL UL/CSA 62368-1
ES60601-1 / CSA 22.2
No.60601-1
 - TUV EN62368-1 / EN60601-1
 - CB Certificate and Report
 - CE Compliance to LVD and RoHS Directives
 - UKCA Mark
 - CQC Approved
 - MIL-STD-810G
 - Medical 2x MOPP
- ** μ MP tested according to the medical standard IEC 60601-1-2 4th Edition.

AT A GLANCE

Total Power

Up to 1800 Watts Peak*

Input Voltage

85 to 264 VAC
120 to 300 VDC

of Outputs

Up to 12

* Max output power for μ MP16: 1000W 85 to 100 VAC; 1200W 100 to 180VAC; 1600 W 180 to 200 V 1800 W 200 to 264 VAC. Operational specs for EMI and Hold-up are valid to 1600 W max



ELECTRICAL SPECIFICATIONS

Input	
Input Range	85 to 264 VAC 120 to 350 VDC (limited to 300 VDC in medical applications)
Frequency	47 to 440 Hz
Inrush Current	40 A peak max. (soft start)
Efficiency	Up to 91.5% @ full case load
Power Factor	0.99 typ. meets EN61000-3-2 (n/a @ 440 Hz)
Standby Power	μMP10/16 < 13 W μMP04/09 < 6 W
Turn-on Time	AC on 2 sec for μMP16/10 and 1.5 sec for μMP04/09, inhibit/enable 250 ms typical
EMI:	CISPR 22/EN55022 Level "B" (Both Conducted and Radiated)
Leakage Current	<200 uA using center-tapped xfmr measurement method. (<400 uA @ 240 VAC input)
Holdover Storage	16.7 ms minimum (independent of input Vac, 0 °C to 50 °C) At 1200 W for μMP16
AC OK	Signal goes low indicating loss of AC input. Hold up = Full cycle ride thru (50 Hz); Open collector
Harmonic Current Emission	Meets EN61000-3-2
Isolation	Meets EN62368 and EN60601
Global Inhibit/Enable	TTL, Logic "1" and Logic "0"; fan off when unit is inhibited
Input Fuse (internal)	μMP16/10: 16 A, 500 VAC 400 VDC, μMP04/09: 10 A / 250 V. (both lines fused)
Warranty	3 years
Output	
Factory Set Point Accuracy	± 1%
Margining / V-Program	± 3 to 7% nominal analog (single output module only). Contact factory for simple V-program modification (i.e. 0-5 V input = 0-100% output voltage).
Overall Regulation	0.4% or 30 mV which ever is greater
Ripple	RMS: 0.1% or 10 mV, whichever is greater Pk-Pk: 1.0% or 50 mV, whichever is greater. Bandwidth limited to 20 MHz
Dynamic Response	< ± 5% or 250 mV, with 50% step load, Min 20% load condition
Recovery Time	To within 1% in < 300 μsec
Reverse Voltage Protection	100% of rated output current
Thermal Protection (OTP)	All outputs disabled when internal temp exceeds safe operating range
Remote Sense	Up to 0.5 V total drop (not available on triple output module)
Single Wire Parallel	Current share to within 5% of total rated current from 20% to 100% rated load
DC OK	± 5% of nominal Open collector
Minimum Load	Not required
Housekeeping Standby	5 VDC @ 2.0 A max whenever AC input is applied. 1.0 A (2.0 A for μMP04) max convection cooled (when output is inhibited off)
Module Inhibit	Logic - output on with low or open. Different logic options available
Output/Output Isolation	500 VDC

ENVIRONMENTAL SPECIFICATIONS

Operating Temperature	-40 to 70°C ambient. Derate each output 2.5% per degree from 50°C to 70°C. Cold start soak -20 °C, allow 10 min warm-up before all outputs are within specification. Reverse air to 40 °C Max due to fan derating.
Storage Temperature	-40 to +85°C
Electromagnetic Susceptibility	Designed to meet EN61000-4:-3,-5,-6,-11 Class 3 Performance Criteria A
Humidity	Operating; non-condensing 10% to 95% RH
Vibration	MIL-STD-810G
MTBF Demonstrated	> 350,000 hours at full load, one μMP04 case + two modules, Telcordia SR-332 calculated MTBF
Altitude	Up to 10 K feet; derate linear to 50% from 10 K to 30 K feet

Vout	Full load (A)	OVP trip typ (V)	OCP trip typ (Iout%)	SCP trip max (Iout%)	Overshoot (max mV)	Peak Deviation (max mV)
3 V 3 Module						
0.9	40	1.90 V	130%	160%	250	± 250
3.3	40	4.46 V	130%	160%	250	± 250
3.6	40	4.82 V	130%	160%	250	± 250
5 V Module						
3.6	36	4.82 V	130%	160%	250	± 250
5	36	6.50 V	130%	160%	250	± 250
6	30	7.70 V	130%	160%	300	± 300
12 V Module						
6	25	7.70 V	130%	160%	300	± 300
12	20	14.90 V	130%	160%	600	± 600
15	16	18.50 V	130%	160%	750	± 750
24 V Module						
12	17	14.90 V	130%	160%	600	± 600
24	10	29.30 V	130%	160%	1200	± 1200
30	8	36.50 V	130%	160%	1500	± 1500
48 V Module						
28	8.5	34.10 V	130%	160%	1400	± 1400
48	5	58.10 V	130%	160%	2400	± 2400
60	4	72.50 V	130%	160%	3000	± 3000

CASE LINE-UP

Case	Max Output		Dimensions	Connections	Max Continuous Current
	85-179 VAC ¹	180-264VAC			
μMP04 - 4 Slot	400 W	600 W	256.9 x 88.9 x 40.0 (10.11" x 3.5" x 1.57")	IEC, Terminal-Block, Barrier-Strip	9.91
μMP09 - 4 Slot	550 W	1000 W	256.9 x 88.9 x 40.0 (10.11" x 3.5" x 1.57")	IEC, Terminal-Block, Barrier-Strip	9.91
μMP10 - 6 Slot	1000 W	1200 W	256.9 x 127 x 40.0 (10.11" x 5.0" x 1.57")	IEC, Terminal-Block, Barrier-Strip	13.87
μMP16 - 6 Slot	1000 W	1800 W	256.9 x 127 x 40.0 (10.11" x 5.0" x 1.57")	IEC, Terminal-Block, Barrier-Strip	13.87

Note1: The input range for μMP09 is 90 to 264Vac.

OUTPUT MODULE LINE-UP S2*

Output Range (Vdc)	Max Current (Amps)	Max Power (Watts)	Module Codes Standard Outputs
0.9 to 3.6	40	144	A, B, C, D - 2, 2.2, 3, 3.3
3.6 to 6.0	40	200	E, F, G, H - 5, 5.2, 5.5, 6.0
6.0 to 15.0	25	240	I, J, K, L, M, N - 8, 10, 11, 12, 14, 15
12.0 to 30.0	17	240	O, P, Q, R, S - 18, 20, 24, 28, 30
28.0 to 60.0	8.5	240	T, U, V, W, X, Y - 33, 36, 42, 48, 54, 60
3.3 to 30.0	4/4	96/96	Dual Output Module. Each output is rated to 96 W (192 Watts total). Wide range is adjustable.

DC OUTPUT MODULE RATING (SK*) 3-SLOTS

Output (Vdc)	MAX Current (Amps)	MAX Power (Watts)	Modules Codes (*) Standard Outputs
6.0 to 15.0	84	1000	H, I, J, K, L, M, N - 6, 8, 10, 11, 12, 14, 15
12.0 to 30.0	42	1000	O, P, Q, R, S - 18, 20, 24, 28, 30
28.0 to 60.0	21	1000	T, U, V, W, X, Y - 33, 36, 42, 48, 54, 60

INTERNAL PART NUMBER REFERENCE TABLE

Part #	Where X =	Description	Module Code
73-951-0001X-G2	T, C, S	μMP10 Cases	μMP10
73-956-0001X-G2	T, C, S	μMP16 Cases	μMP16
73-963-XXXX	0012, 0024, 0048, 04XX	uMP 1000W Module	SKL to SKZ
73-963-00XX-G2	0012, 0024, 0048, 04XX	uMP 1000W Module	SKL to SKZ

ORDERING INFORMATION

μMPXY	SKW - S2E - S2Q - ILL	00	A	###
<p>Case Size</p> <p>1-Phase Input where X = 04 = 1.57" x 3.5" x 10.0"; 400W - 600W 4 Slots 09 = 1.57 x 3.5 x 10.0, 550W-1000W 4 Slots 10 = 1.57 x 5.0" x 10.0", 1000W-1200W, 6 Slots 16 = 1.57" x 5.0" x 10.0", 1200W-1800W**, 6 Slots</p> <p>** See Output derating table below for uMP16</p> <p>Input Type where Y = T = Terminal Block C = IEC Connector C14 S = Barrier Strip</p>	<p>Module Codes: S2 = 200 W Single O/P (1 Slot) SK = 1000 W Single O/P (3 Slot) I = 96 W Dual O/P ISO GND (1 Slot) HUP = Hold-Up Module (10ms for 500W /1 Slot)</p> <p>Voltage Codes: See voltage code table</p>	<p>First digit 0-9 = Parallel Code</p> <p>Second Digit 0 = No Options 1 = Reverse Air 2 = Not Used 3 = Global Enable 5 = Opt 1 + Opt 3</p>	<p>Factory assigned for modified standards</p>	

μMP16 OUTPUT POWER DERATING

Parameter	85 - 99 VAC	100 - 179 VAC	180 - 199 VAC	200 - 264 VAC
Output Power	1000 W	1200 W	1600 W	1800 W

PARALLEL CODES

Code	Slots in Parallel	Code	Slots in Parallel	Code	Slots in Parallel	Code	Slots in Parallel
1	1&2	6	1&2&3	A	1&2; 3&4	0	no module in parallel
2	2&3	7	1,2,3&4	B	1,2&3; 4&5	H	3,4&5
3	3&4	8	1,2,3,4&5	C	1,2,3&4; 5&6	J	3,4,5&6
4	4&5	9	1,2,3,4,5&6	D	1&2; 3&4; 5&6	K	4,5&6
5	5&6			E	1,2&3; 4,5&6		

Notes:
 Parallel between SK* (1000 W Modules) and S2* (240 W Modules) will use the codes as follows
 Code 3 to parallel 2 SK* modules
 Code 3 to parallel 1 SK* module and 1 S2* module
 Code H to parallel 1 SK* module and 2 S2* modules

VOLTAGE CODES

Standard Output Ratings					
Module Output Voltage Code		Single Output One Slot 240 Watts Max	Single Output Three Slots 1000 Watts Max	Dual Output One Slot 96 Watts	
Module Identification		S2	SK	I	
Code	Volts	Output Current V1	Output Current V1	Output Current	
				V1	V2
A	2.0	40.0	-	NA	
B	2.2	40.0	-	NA	
C	3.0	40.0	-	NA	
D	3.3	40.0	-	4.0	4.0
E	5.0	36.0	-	4.0	4.0
F	5.2	34.0	-	4.0	4.0
G	5.5	32.0	-	4.0	4.0
H	6.0	30.0	84.0	4.0	4.0
I	8.0	25.0	84.0	4.0	4.0
J	10.0	24.0	84.0	4.0	4.0
K	11.0	21.8	84.0	4.0	4.0
L	12.0	20.0	84.0	4.0	4.0
M	14.0	17.1	71.4	4.0	4.0
N	15.0	16.0	66.6	4.0	4.0
O	18.0	13.0	42.0	4.0	4.0
P	20.0	12.0	42.0	4.0	4.0
Q	24.0	10.0	41.6	4.0	4.0
R	28.0	8.5	35.7	3.4	3.4
S	30.0	8.0	33.3	3.2	3.2
T	33.0	7.0	21.0	NA	
U	36.0	6.6	21.0	NA	
V	42.0	5.7	21.0	NA	
W	48.0	5.0	20.8	NA	
X	54.0	4.4	18.5	NA	
Y	60.0	4.0	16.6	NA	

DERATING CURVES - μMP10

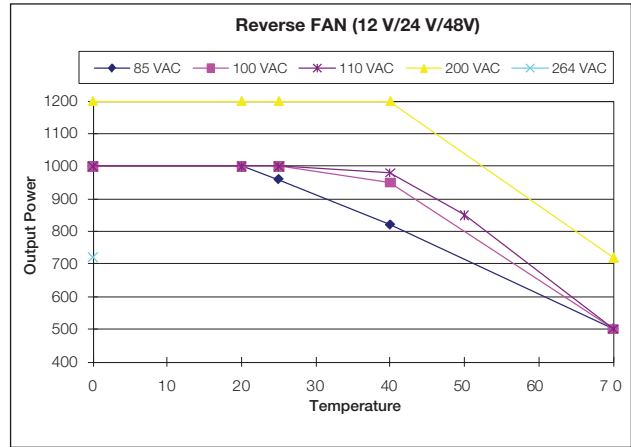
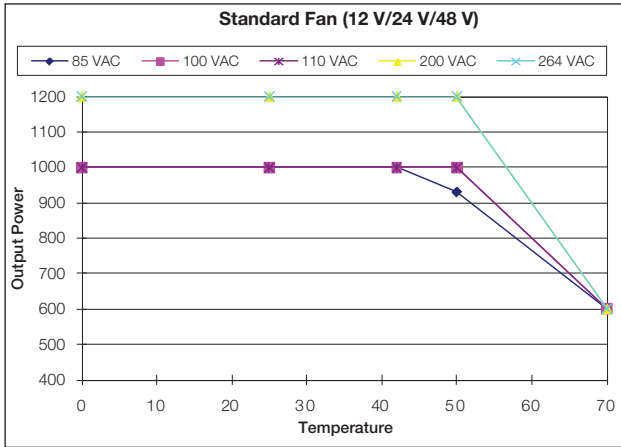

μMP04/09 (AC input on opposite side)

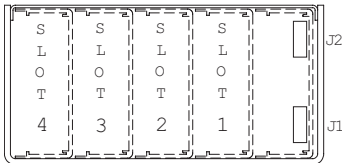

	Input	
	85 - 264 VAC	200 - 264 VAC
μMP04 = 4 available slots	400 W max.	600 W max.
μMP09 = 4 available slots	550 W max.	1000 W max.

μMP10/16 (AC input on opposite side)

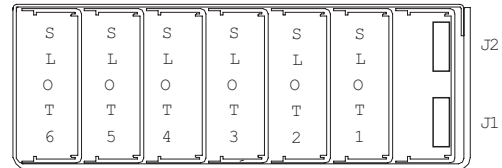

	Input	
	85 - 264 VAC	200 - 264 VAC
μMP10 = 6 available slots	1000 W max.	1200 W max.
μMP16 = 6 available slots	1200 W max.	1800 W max.

PIN CONNECTORS

Figure 1. AC Input

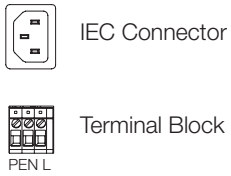

AC Input	
Pin	Function
1	AC neutral
2	AC line (hot)
3	Chassis (earth) ground

Mates with
Landwin 2050S1000 Housing
2053T011V Pin
or
JST PHDR-10VS Housing
JST SPHD-002T-P0.5 (28-24)
JST SPHD-001T-P0.5 (26-22)

J2

I ² C Bus Output Connector	
Pin	Function
1	5 Vcc bus
2	Serial data signal (SDA)
3	Secondary return (COM)
4	Serial clock signal (SCL)
5	Address bit 2 (A2)
6	No connection
7	Address bit 1 (A1)
8	No connection
9	Address bit 0 (A0)
10	No connection

Advanced Energy Connector
Kit PN: 70-841-023
Sager Electronics Cable
Assembly PN: 2174500058

J1

PFC Input Connector (control & signals)	
Pin	Function
1	Input AC OK - "emitter"
2	Input AC OK - "collector"
3	Global DC OK - "emitter"
4	Global DC OK - "collector"
5	Spare
6	Global inhibit/optional enable logic "1"
7	Global inhibit/optional enable logic "0"
8	Global inhibit/optional enable return
9	+5 VSB housekeeping
10	+5 VSB housekeeping return

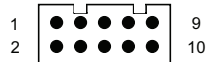
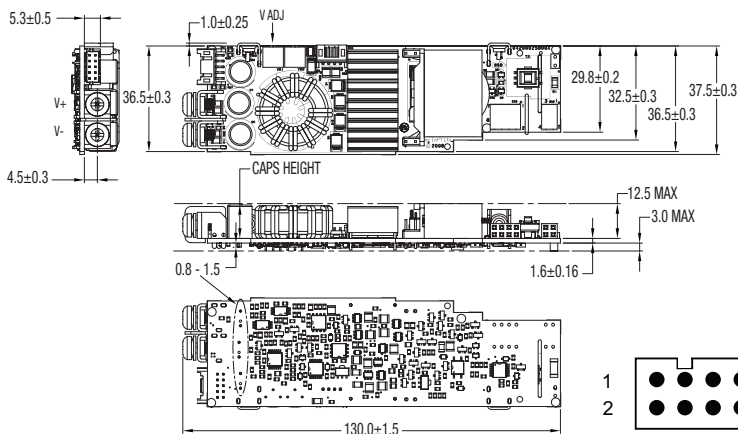
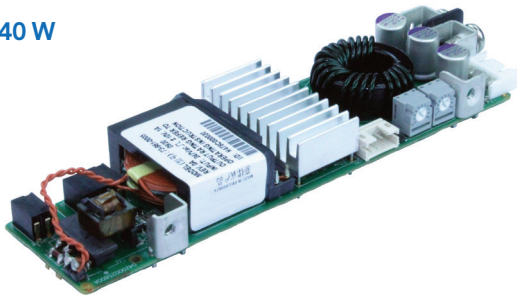

Figure 2. Connector J1 & J2

S2 MODULE

240 W



DC Output Control & Signals (Single output)

Pin	Function
1	No connection
2	No connection
3	Current share
4	Module inhibit return
5	Module ISO inhibit
6	SCOM
7	-RMT sense
8	Margin
9	Remote margin / V prog.
10	+RMT sense

SK MODULE

1000 W 48 V Outputs

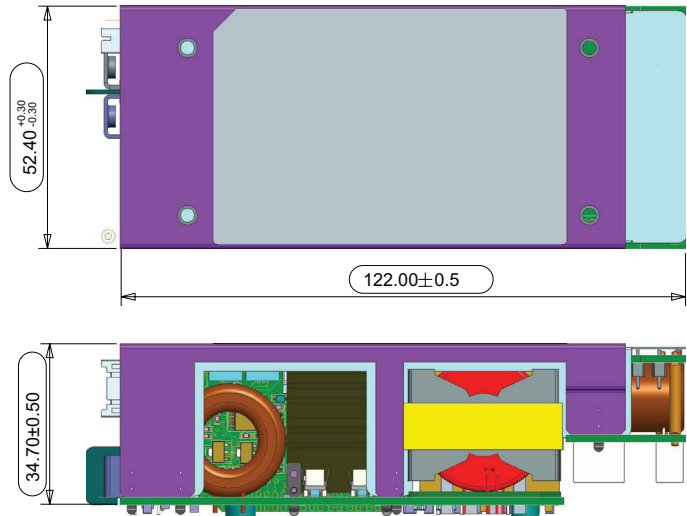
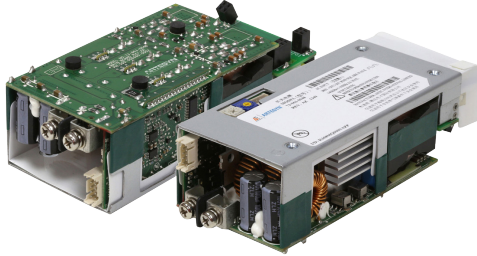

1000 W 12/24 V Output:

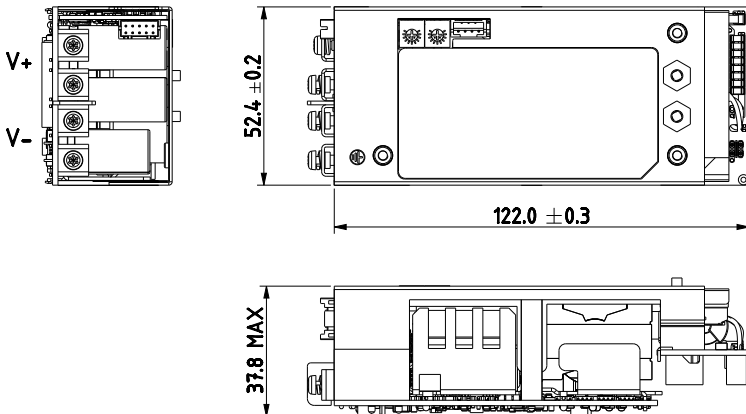
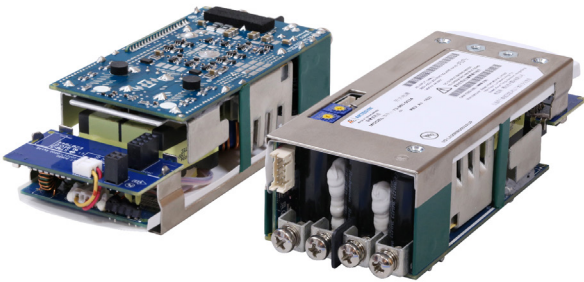

DC Output Control & Signals (Single output)	
Pin	Function
1	No connection
2	No connection
3	Current share
4	Module inhibit return
5	Module ISO inhibit
6	SCOM
7	-RMT sense
8	Margin
9	Remote margin / V prog.
10	+RMT sense

DUAL MODULE

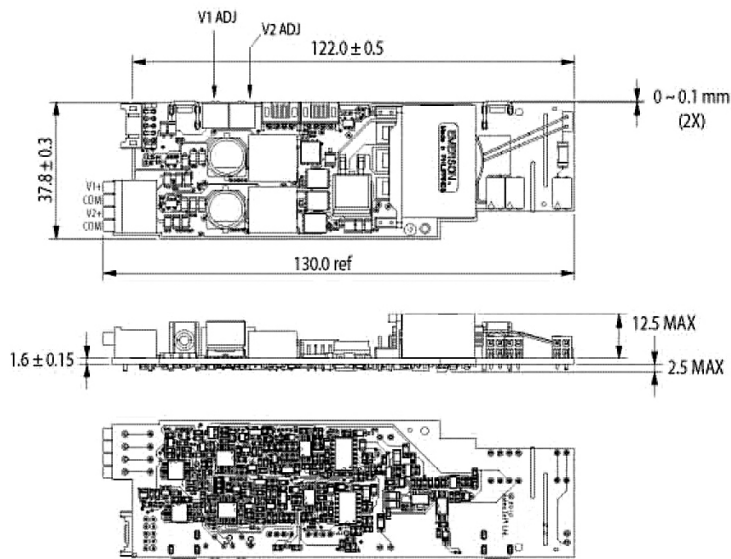
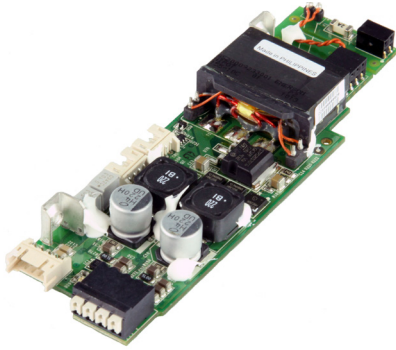

DC Output Control & Signals (Dual output)	
Pin	Function
1	-RMT sense V2
2	+RMT sense V2
3	No connection
4	Module inhibit rtn
5	Module ISO inhibit
6	SCOM
7	-RMT sense V1
8	No connection
9	No connection
10	+RMT sense V1

μMP SERIES

μMP04/09 (400/600; 550/1000 Watts Max)

Case Size: μMP04/09: 10.11" x 3.5" x 1.57" (256.9 mm x 88.9 mm x 40.0 mm)

Weight: μMP04/09 Case: 927g · S2 Module 105g, SK Module 343g.

· Dual O/P: 74g. · HUP Module: 81g.

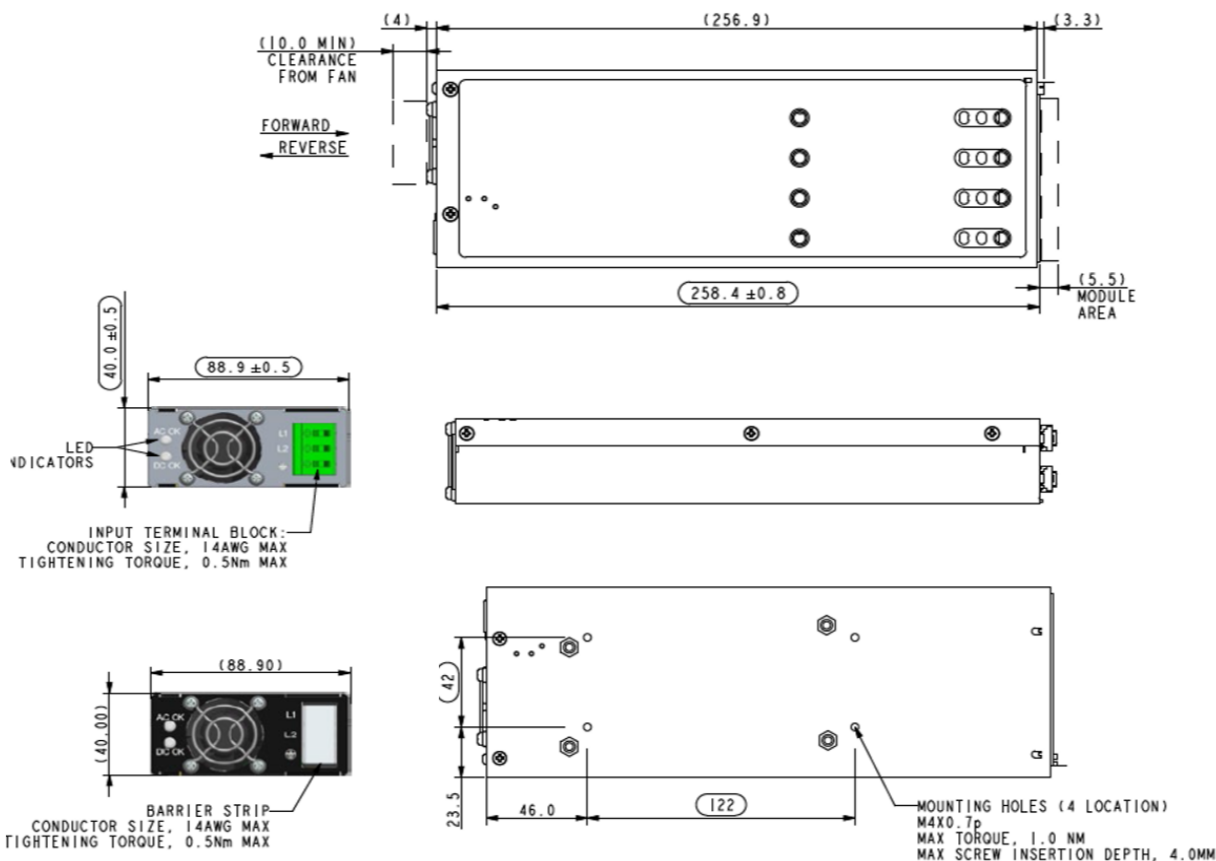

“S” Version



“C” Version



“T” Version

Notes:

1. Input: IEC 60320 C13 (for IEC connector)
Barrier Type DECA Switchlab MT300-50003 (for terminal block connector); Max Torque: 4.0 lb-in (0.4 - 0.5 Nm); Wire: 12 - 16 AWG; Wire Strip Length: 0.354" (9.0 mm)
2. Control Connectors (J1 and J2): 10-position housing, brass, matte tin-plated contacts. Mates with housing 2050S1000 (Landwin) with 2053T011P (Landwin) pins or housing PHDR-10VS (JST) and SPHD- 002T-PO.5 (JST) pins.
3. Output Module Connectors: All single O/P modules are M4 x 10 mm screws; tighten between 6.94 to 8.68 lb-in (8.0 to 10.0 kg-cm). Dual O/P module is PUSH IN conductor connector; Wire Strip Length: 0.315" (8.0 mm); Control signal connector: Refer to Item 2.
4. Chassis Material: Steel with chemical film coating (conductive).
5. Customer Mounting: Screw M4-type mounting holes; Max. Penetration is 0.138" (3.5 mm); Max. Torque: 8.85 lb-in (1.0 N-m)
6. All dimensions are in millimeters and inches, and are typical.

μMP SERIES (CONTINUED)

μMP10 (1000/1200 Watts Max)

μMP16 (1200/1800 Watts Max)

Case Size: μMP10/16: 10.11" x 5" x 1.57" (256.9 mm x 127 mm x 40.0 mm)

Weight: μMP10/16 Case: 1305g · S2 Module 105g, SK Module 343g.

· Dual O/P: 74g · HUP Module: 81g

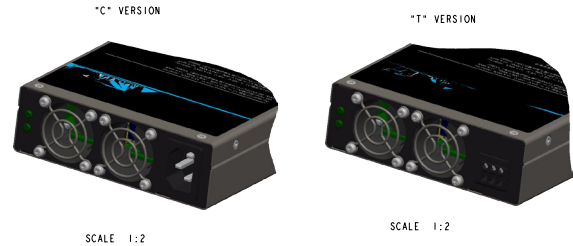
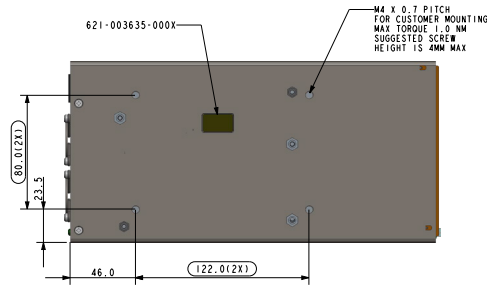
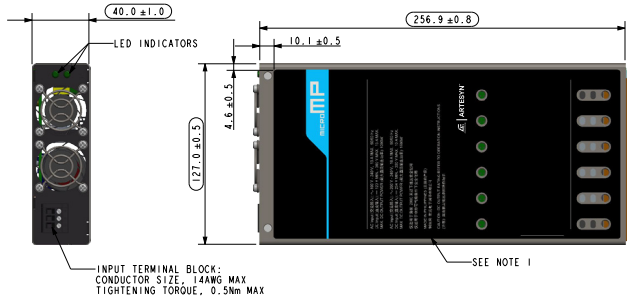

NOTES
 1. BLACK TOP COVER LABEL, REFER TO IPN 534-000824-000X FOR DETAILS.
 2. DIMENSIONS ARE IDENTIFIED FOR INSPECTION BY BEING ENCLOSED IN AN OBOUND.

AC Input Marking:

μMP10T/μMP10S/μMP16T/μMP16S:L,N and PE



μMP10C/μMP16C: No Marking

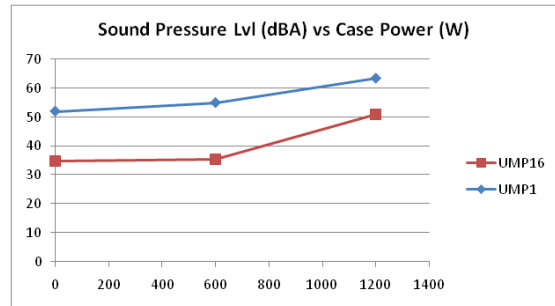
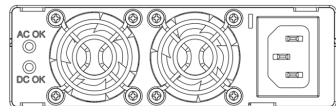

Notes:

- Input: IEC 60320 C13 (for IEC connector)
 Barrier Type DECA Switchlab MT300-50003 (for terminal block connector); Max Torque: 4.0 lb-in (0.4 - 0.5 Nm); Wire: 12 - 16 AWG; Wire Strip Length: 0.354" (9.0 mm)
- Control Connectors (J1 and J2): 10-position housing, brass, matte tin-plated contacts. Mates with housing 2050S1000 (Landwin) with 2053T011P (Landwin) pins or housing PHDR-10VS (JST) and SPHD-002T-PO.5 (JST) pins.
- Output Module Connectors: All single O/P modules are M4 x 10 mm screws; tighten between 6.94 to 8.68 lb-in (8.0 to 10.0 kg-cm). Dual O/P module is PUSH IN conductor connector; Wire Strip Length: 0.315" (8.0 mm); Control signal connector: Refer to Item 2.
- Chassis Material: Steel with chemical film coating (conductive).
- Customer Mounting: Screw M4-type mounting holes; Max. Penetration is 0.138" (3.5 mm); Max. Torque: 8.85 lb-in (1.0 N-m)
- All dimensions are in millimeters and inches, and are typical.
- Sound Pressure Level vs Case Power curve: Gen 1 uMP1 and Gen 2 uMP10/16 data comparison.

μMP HUP MODULE

The μMP HUP module is intended for use on μMP09 with high efficiency module (SK*) configurations. In such case, only one HUP can be used per case.

Its application is limited with μMP09 and μMP04 configurations and may have multiple HUP's inserted.

The HUP module shall provide additional 224μF bulk capacitance (typ.). Typical hold-up time increase with HUP module in μMP09 case and SK* module is 10ms at 500W load.



73-950-002

Actual μMP HUP Module and μMP09 Configuration



μMP09 Config with HUP at Slot1

Typical HUP Response with μMP09-SKW Configuration

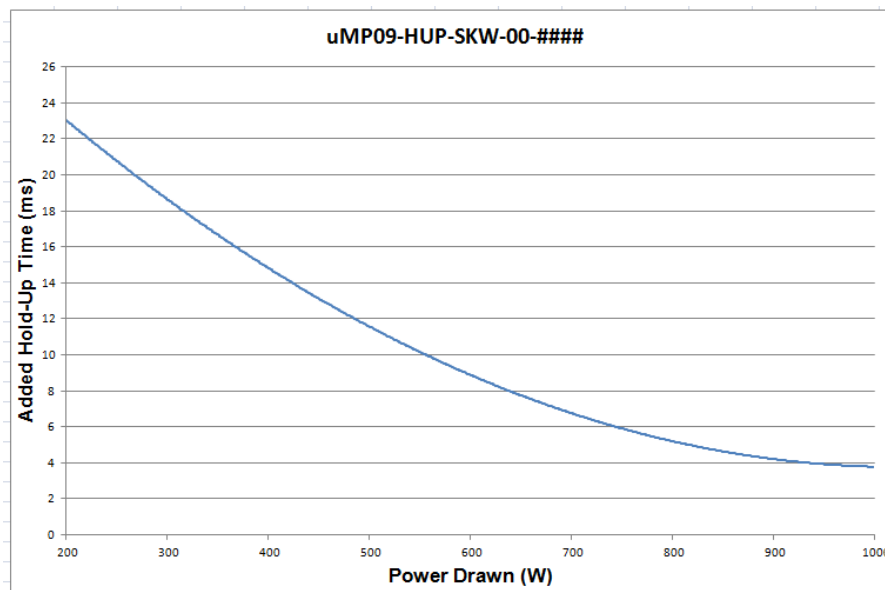

μMP HUP MODULE (CONTINUED)

Typical HUP Response with μMP09-S2* Configuration

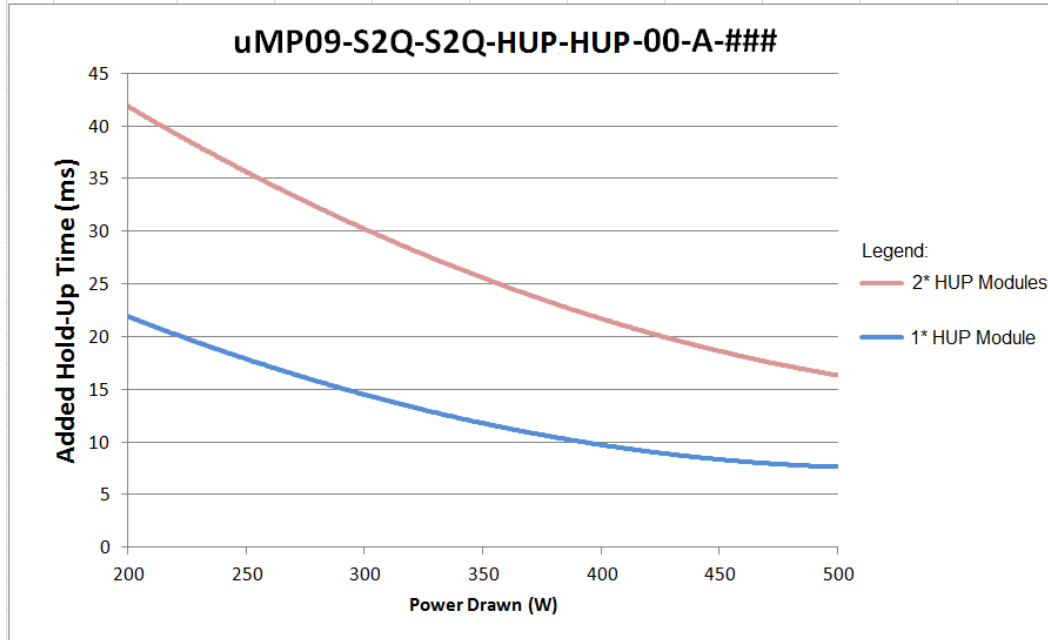



For international contact information,
visit advancedenergy.com.

powersales@aei.com (Sales Support)
productsupport.ep@aei.com (Technical Support)
+1 888 412 7832

ABOUT ADVANCED ENERGY

Advanced Energy (AE) has devoted more than four decades to perfecting power for its global customers. AE designs and manufactures highly engineered, precision power conversion, measurement and control solutions for mission-critical applications and processes.

Our products enable customer innovation in complex applications for a wide range of industries including semiconductor equipment, industrial, manufacturing, telecommunications, data center computing, and medical. With deep applications know-how and responsive service and support across the globe, we build collaborative partnerships to meet rapid technological developments, propel growth for our customers, and innovate the future of power.

PRECISION | POWER | PERFORMANCE | TRUST

Specifications are subject to change without notice. Not responsible for errors or omissions. ©2025 Advanced Energy Industries, Inc. All rights reserved. Advanced Energy®, and AE® are U.S. trademarks of Advanced Energy Industries, Inc.