

SL POWER NGB425 SERIES

425 Watts Single Output
Medical & Industrial Grade

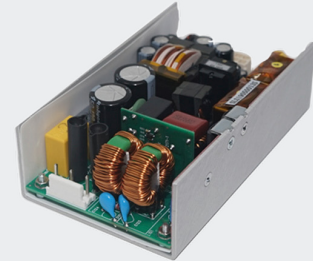

Medical



Industrial



LED/AV

Advanced Energy's SL Power NGB425 medically-approved AC-DC power supplies are available with a nominal main output of 12 V, 15 V, 24 V or 48 V. NGB425 power supplies provide up to 425 Watts of output power with air flow. All models have output overvoltage, short circuit and overload protection and a 3 x 5 x 1.5 inch form factor.

AT A GLANCE

Total Power

425 Watts

Input Voltage

85 to 264 VAC

of Outputs

Single

SPECIAL FEATURES

- Up to 425 Watts with Air Flow
- Up to 270 Watts Convection Cooled
- 3"W x 5"L x 1.5"H Size
- Universal Input 85 to 264 VAC
- Meets Class B Emissions Levels
- 10+ Years Electrolytic Capacitor Life
- -20°C to 80°C Operating Temperature Range
- Meets Heavy Industrial/IEC60601-1-2 4th Edition EMC
- Less than 100 uA Leakage Current
- Class I and Class II Input Versions Available
- ROHS Compliant
- REACH Compliant
- 3 Years Warranty
- Covered Versions Available (Add "-C" to Model No.)

SAFETY

- IEC/UL/EN60601-1, 3rd Edition + Am1
- IEC/UL/EN62368-1



ELECTRICAL SPECIFICATIONS

Input						
Parameter	Conditions/Description	Min	Nom	Max	Units	Modification
Input Voltage	Single phase, safety approved (tested also at 80 VAC)	85	115/230	264	VAC	Contact AE
Input Current	4.2 A max at 115 VAC, 2.1 A at 230 VAC	2.1	-	4.2	A	
Input Fuses	250 VAC fuse in both line and neutral	-	6.3	-	A	Contact AE
Turn-On Input Voltage	Ramping up	-	80	-	VAC	Contact AE
Turn-Off Input Voltage	Ramping down	-	75	-	VAC	Contact AE
Input Frequency	-	47	50/60	63	Hz	400 Hz
Inrush Current Limitation	264 VAC, cold start	-	-	40	A	Active limit circuit
Power Factor	-	-	0.9	-	W	See performance data
No Load Input Power	-	-	-	0.5	W	-
Leakage Current						Lower leakage current values achievable, contact AE for modification requests
Earth leakage current	<500 µA @ 264 VAC, 60 Hz, NC					
Patient leakage current	<100/500 µA @ 264 VAC, 60 Hz, NC/SFC					
Isolation						
Input to Ground ²	2000 VAC, 1 MOPP					
Input to Output	4750 VAC, 2 MOPP					
Output to Ground ²	2000 VAC, 1 MOPP					

Notes:

1. Unless otherwise noted, all parameters are specified at nominal input (115/230 VAC), 25°C ambient operating temperature, no load to full rated output power, and nominal output voltage.
2. Class I only.

Output			
Parameter	Conditions/Description	Value	Modification
Output Power	See "Ordering Information"	-	
Hold Up Time	Typ., measured at 100VAC/60Hz, 80% load. Performance data available upon request	20 ms	
Peak Rating	For duty cycle <10%, ambient temperature <40°C, duration <1 ms	150%	
Ripple and Noise	%Vout on all models (peak to peak) ²	1%	
Load Regulation	%Vout on all models	±2%	
Line Regulation	%Vout on all models	±1%	
Total Regulation	%Vout on all models	±5%	
Minimum Load	Not required	-	Contact SLPE for other output and load condition requirements.
Initial Set Point Tolerance	%Vout on all models	±1%	
Output Adjustability	%Vout on all models	±5%	
Overshoot at Turn-on	Under all conditions	<5%	
Overshoot at Turn-off	Under all conditions	<1%	
Capacitive Load	Nominal tested capacitance, values vary with respect to output voltage. Contact AE for detailed requests	1000µF	
Monotonic Waveform	Main output at start up, shut down and fault (OVP, OCP, OTP, OPP, SCP) triggered shutdown		
Transient Response	500 µs response time for return to within 0.5% of final value for any 50% load step over the range of 25% to 100% of rated load, Δi/Δt< 0.2 A/µs. Max. voltage deviation is ±3.5% of final value		

Notes:

1. Unless otherwise noted, all parameters are specified at nominal input (115/230 VAC), 25°C ambient operating temperature, no load to full rated output power, and nominal output voltage.
2. See "FEATURES" section for measurement method description.

ELECTRICAL SPECIFICATIONS

Reliability	
MTBF	>500K hrs, 25°C, full rated load at 110 VAC input.
Warranty	3 years
Electrolytic Capacitor Lifetime	All specified electrolytic capacitors exceed 10 year life based on operating at 25°C ambient temp, 24 hrs/day, 365 days/year, 6 power up cycles/day.

Protection			
Parameter	Conditions/Description	Mode	Modification
Overvoltage Protection	115% to 155% of nominal output voltage	Hiccup Mode	Contact AE
Short Circuit Protection	Short across the output terminals will not cause damage to the unit	Latch-off Mode ¹	
Thermal Protection	Will shut down upon an overtemperature condition	Auto-recovery	
Overload Protection	130%–180% of rated output current value	Hiccup Mode	

Note:

1. Turn off/on with inhibit or reset of AC input voltage will restart the power supply.

EMI/EMC COMPLIANCE¹

Parameter	Conditions/Description
Conducted Emissions	EN55011/15/32: Class B, CISPR11/15/32: Class B, FCC Part 15.107, Class B, Measured at 10%, 50%, and 100% load steps; 6db margin typ, at 120 VAC and 230 VAC
Radiated Emissions	EN55011/15/32: Class B, CISPR11/15/32: Class B, FCC Part 15.107, Class B, Measured at 10%, 50%, and 100% load steps; 3db margin typ, at 120 VAC and 230 VAC
Harmonic Current Emissions	EN61000-3-2, Class A at 230 VAC, 100% load
Voltage Fluctuations & Flicker	IEC61000-3-3
Electrostatic Discharge Immunity	EN55024/IEC61000-4-2, Level 4: ±8kV contact, ±15kV air, Criteria A, IEC60601-1-2, 4 th Edition, Table 4
Radiated RF EM Fields Susceptibility	EN55022/EN61000-4-3, 10 V/m, 80 MHz to 2.7 GHz, 80% AM at 1 kHz IEC60601-1-2, 4 th Edition, Table 4
Electrical Fast Transients / Bursts	EN55024/IEC61000-4-4, Level 4, ±4 kV, 100 Khz rep rate, 40 A, Criteria A, IEC60601-1-2, 4 th Edition, Table 5
Surges Line to Line (DM) and Line to Ground (CM)	EN55024/IEC61000-4-5, Level 4, ±2kV DM, ±4kV CM, Criteria A Surpasses IEC60601-1-2, 4 th Edition requirements
Conducted Disturbances Induced by RF Fields	EN55022/IEC61000-4-6, 3 V/m – Level 4, 0.15 to 80 MHz; and 12V/m in ISM and amateur radio bands between 0.15 MHz and 80 MHz, 80% AM at 1 KHz IEC60601-1-2, 4 th Edition, Table 5
Rated Power Frequency Magnetic Fields Test	EN55024/IEC1000-4-8, Level 4: 30 A/m, 50Hz/60Hz IEC60601-1-2, 4 th Edition, Table 4
Voltage Dips	EN55024/IEC/EN61000-4-11: --100% dip for 10 ms, at 0°, 45°, 90°, 135°, 180°, 225°, 270° and 315° --100% dip for 20 ms, 0°, criteria B (criteria A at 70% output) --100% dip for 5000 ms (250/300 cycles), criteria B --60% dip for 100 ms, criteria B --30% dip for 500 ms, criteria B IEC60601-1-2, 4 th Edition, Table 5
Common Mode Noise: High Freq. (100 KHz to 20 MHz)	500 mA pk-pk

Notes:

1. Performance criteria are based on EN55024. According to the standards, performance criteria are decoded as following:

- A. Normal performance during and after the test
- B. Temporary degradation, self-recoverable
- C. Temporary degradation, operator intervention required to recover the operation
- D. Permanent damage

2. Contact AE for modification range.

DERATING

Input Derating					
Input Voltage	12V/15V (Air)	24-48V (Air)	12V (Conv)	15V (Conv)	24-48V (Conv)
80 VAC	282 W	328 W	203 W	173 W	220 W
90 VAC	329 W	382 W	235 W	200 W	270 W
100-264 VAC	365 W	425 W	235 W	200 W	270 W

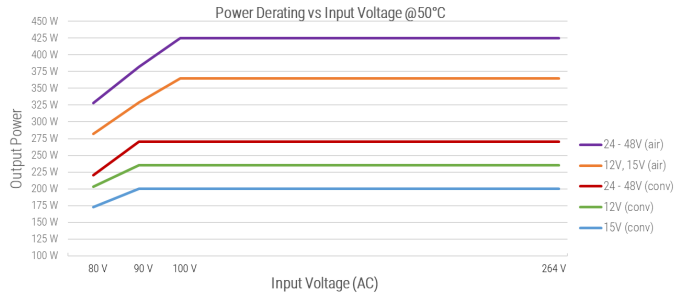

Temp Derating					
Ambient Temp	12V/15V (Air)	24-48V (Air)	12V (Conv)	15V (Conv)	24-48V (Conv)
-10°C - 50°C	365 W	425 W	235 W	200 W	270 W
60°C	274 W	319 W	176 W	150 W	203 W
70°C	183 W	213 W	118 W	100 W	135 W
80°C	91 W	106 W	59 W	50 W	68 W

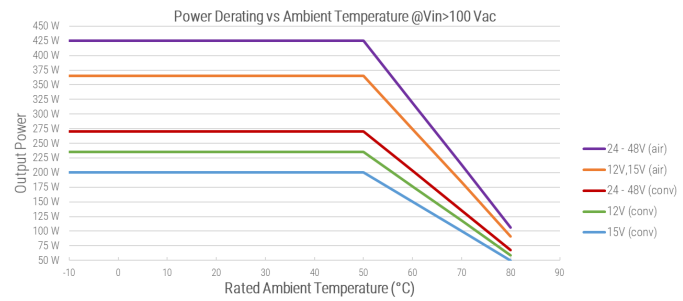

BLOCK DIAGRAM

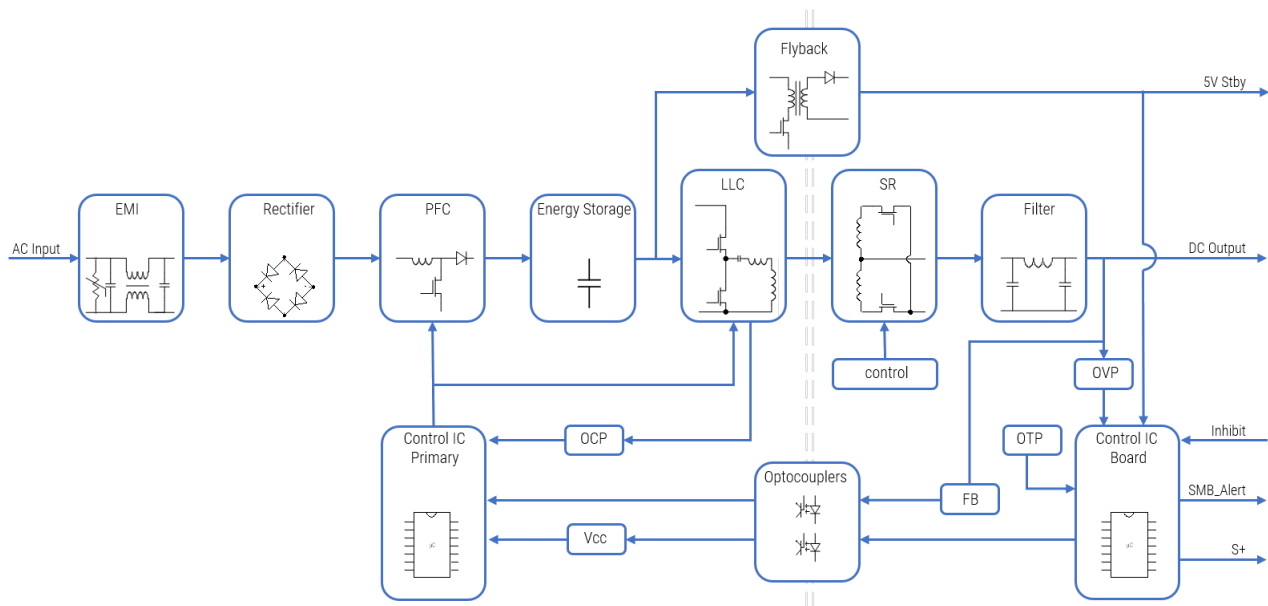

ORDERING INFORMATION

Model Number ²	Output Voltage	Output Current (w/air)	Output Power (w/air) ³	Output Current (convection)	Output Power (convection)	Standby Output	Fan Output
NGB425S12K	12 V	30.0 A	365 W	19.5 A	238 W	5Vdc @ 1A	Custom modifications available upon request. Contact AE for modification.
NGB425S15K	15 V	24.0 A	365 W	13.2 A	200 W		
NGB425S24K	24 V	17.5 A	425 W	11.2 A	270 W		
NGB425S48K	48 V	8.75 A	425 W	5.6 A	270 W		
NGB425S12C	12 V	30.0 A	365 W	19.5 A	238 W	5Vdc @ 1A	
NGB425S15C	15 V	24.0 A	365 W	13.2 A	200 W		
NGB425S24C	24 V	17.5 A	425 W	11.2 A	270 W		
NGB425S48C	48 V	8.75 A	425 W	5.6 A	270 W		
NGB425SxxZyy	±10%	custom	custom	custom	custom	custom	

Notes:

- Includes 5 V standby power (5 W w/air, 2.5 W convection).
- Suffix "K" denotes Class I input and suffix "C" denotes Class II input.
- Unless otherwise noted, all parameters are specified at nominal input (115/230 VAC), 50°C ambient operating temperature. Output power is derated to 70% of rated for units with covers (-C options).

ENVIRONMENTAL SPECIFICATIONS

Parameter	Conditions/Description
Operating Temperature	-20°C to +80°C
Temperature Derating	Derate output power linearly above 50°C. See derating curve for details.
Relative Humidity	5% to 95%, non-condensing
Altitude	Operating: -500 to 5,000 m. Non-operating: -500 to 12,192 m
Storage Temperature	-40°C to +85°C
Vibration	Random Vibration: Operating: 0.003 g/Hz, 1.5 grams overall, 3 axes, 10 min/axis, 5 to 500 Hz. Non-operating: Random waveform, 3 mins/axis, 3 axes and sine waveform, Vib. frequency / acceleration: 10 Hz to 500 Hz / 1 g, sweep rate of 1 octave/minutes, vibration time of 10 sweeps/axes, 3 axes. Transportation vibration: Random vib. per MIL-STD-810E, Method 514.4, Cat. 1, Figure 514.4-1, 1hr in each of three axes.
Shock (IEC 60068-2-27)	Operating: Half-sine, 20 gpk, 10 ms, 3 axes, 6 shocks total. Non-operating: Half-sine waveform, impact acceleration of 50 g, pulse duration of 6 ms. Number of shocks: 3 for each of the three axis
Cooling	400 LFM of airflow, natural convection.. See "Ordering Information" for applicable output ratings.
Audible Noise	<20 dbA

Note: Contact AE for custom requirements or modifications requests.

SAFETY

Certification	Description
UL	UL62368-1, UL60601-1-1, 3rd Edition + Am1. Complies with BF rated application requirements.
CSA	CAN/CSA-C22.2 No. 62368-1, 60601-1, Am1. Complies with BF rated application requirements.
Demko	EN62368-1, EN60601-1-1, 3rd Edition + Am1. Complies with BF rated application requirements.
CB Report	Design to meet 5000 m and 50°C, 93% RH with 120 h (Tropical standard) according to GB4943 1-2011, IEC62368-1, IEC60601-1-1 Am1. Complies with BF rated application requirements.

Note: Custom certifications available upon request. Contact AE for additional certification and regional approvals requirements.

SYSTEM TIMING SPECIFICATIONS

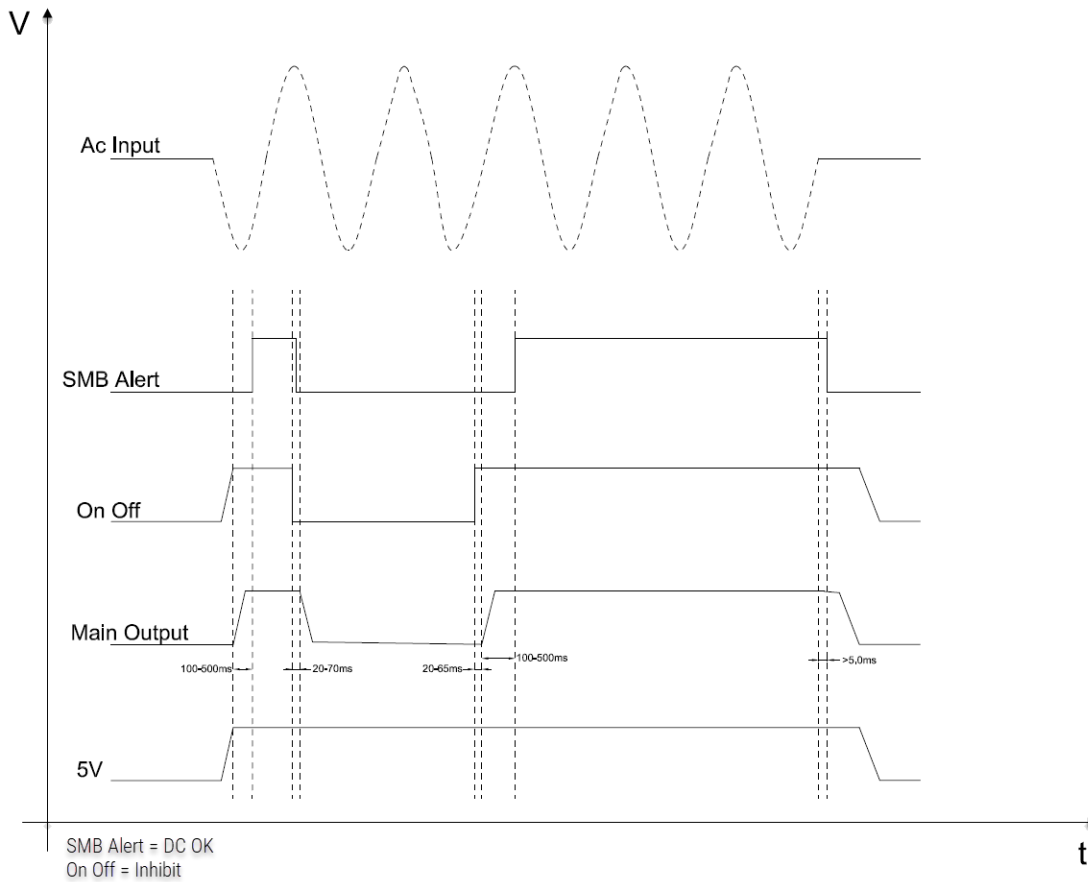

SIGNALS DESCRIPTION

Function	Description
RTN	Return paths for all auxiliary connections. Not isolated from DC output return.
NC	Not connected, no function.
S+	Positive remote sense; use RTN for S- path; Typical voltage compensation 200 mV.
SMB_Alert ¹	DC OK signal
INHIBIT	On = open or logic HIGH (3.4 V to 5 V); off = RTN or logic LOW (< 0.8 V).
+5V	Standby voltage 5V DC, 1A max. always present.

Note:

1. SMB_Alert signal will be high once the DC output rises to within the regulation (on turn-on), and go low if the DC output falls below the regulation range.

The SMB_Alert is an output signal driven high by the power supply to indicate that all outputs are valid. If any of the power supply outputs fails below its regulation limits, this output will be driven low. The output signal is an open drain output internally pulled up in the power supply to internal standby supply.

MECHANICAL DRAWING

Class I input version:

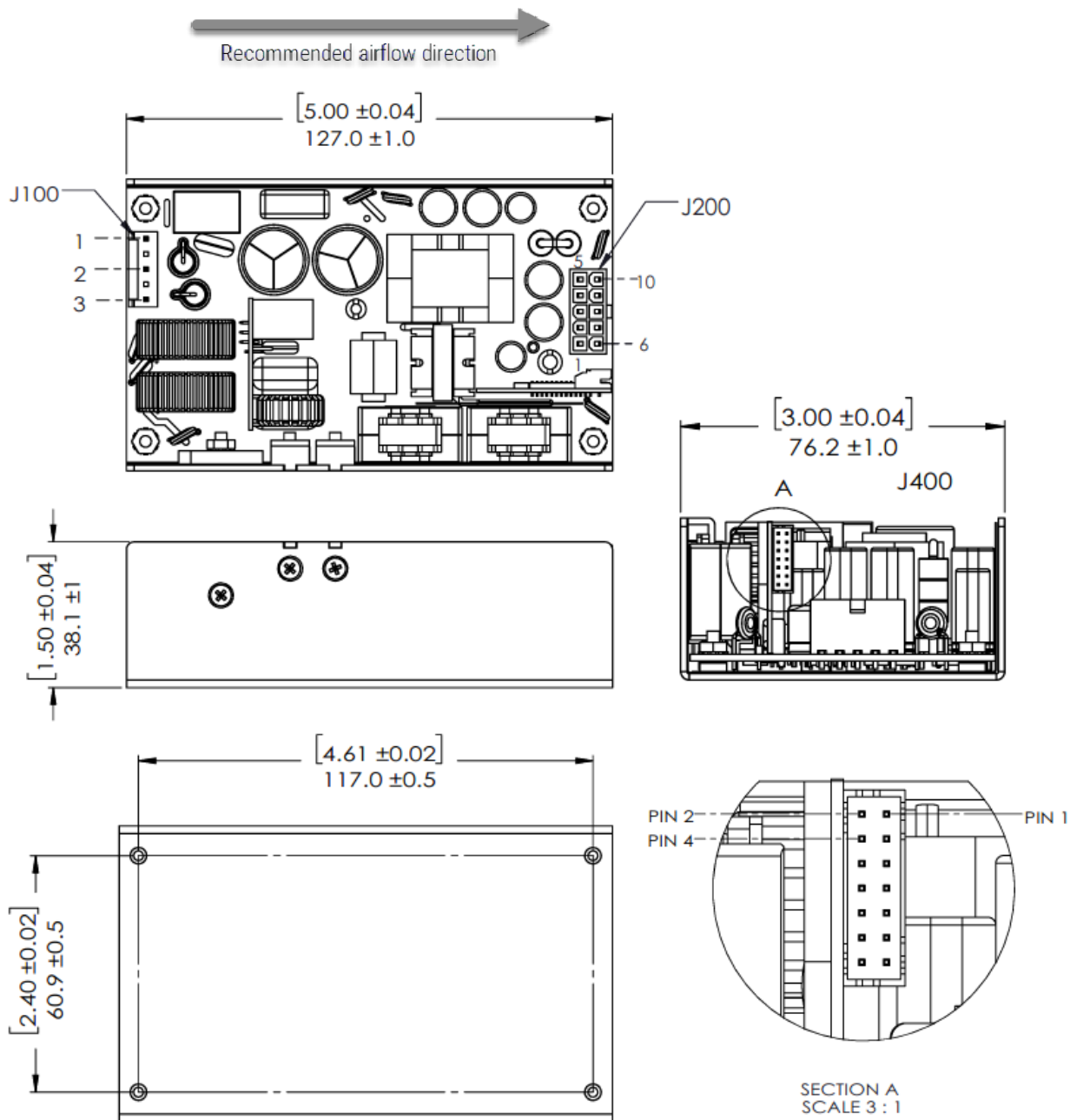

For customer install
4x M3x0.5mm
screw penetration
3.0mm Max.

Notes:

1. All dimensions in mm (inches).
2. Dimensions: W: 3" x L: 5" x H: 1.5".
3. Unit weight: 490 g.

MECHANICAL DRAWING

Class II input version:

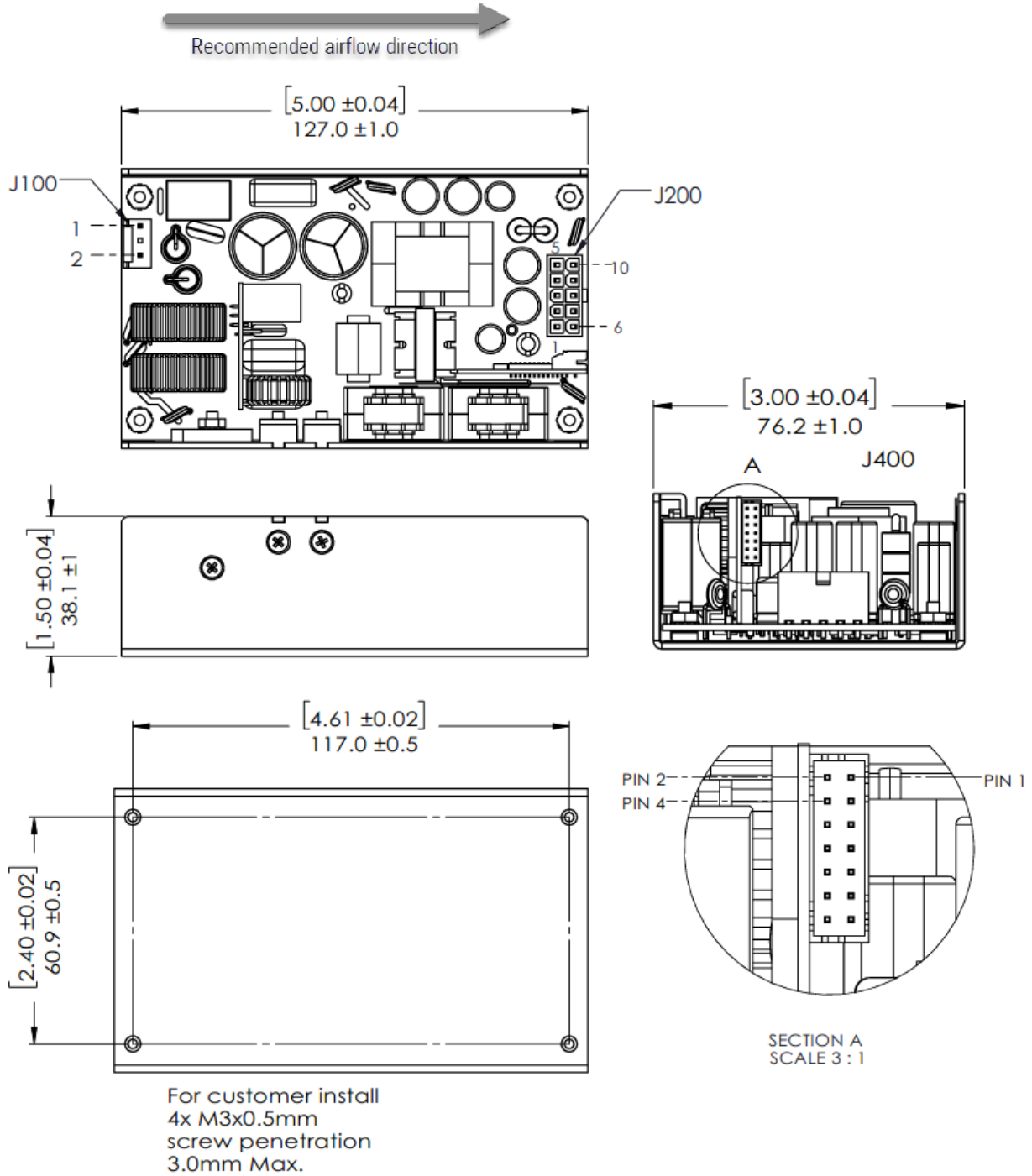

Notes:

1. All dimensions in mm (inches).
2. Dimensions: W: 3" x L: 5" x H: 1.5".
3. Unit weight: 490 g.

MECHANICAL DRAWING

Covered version:

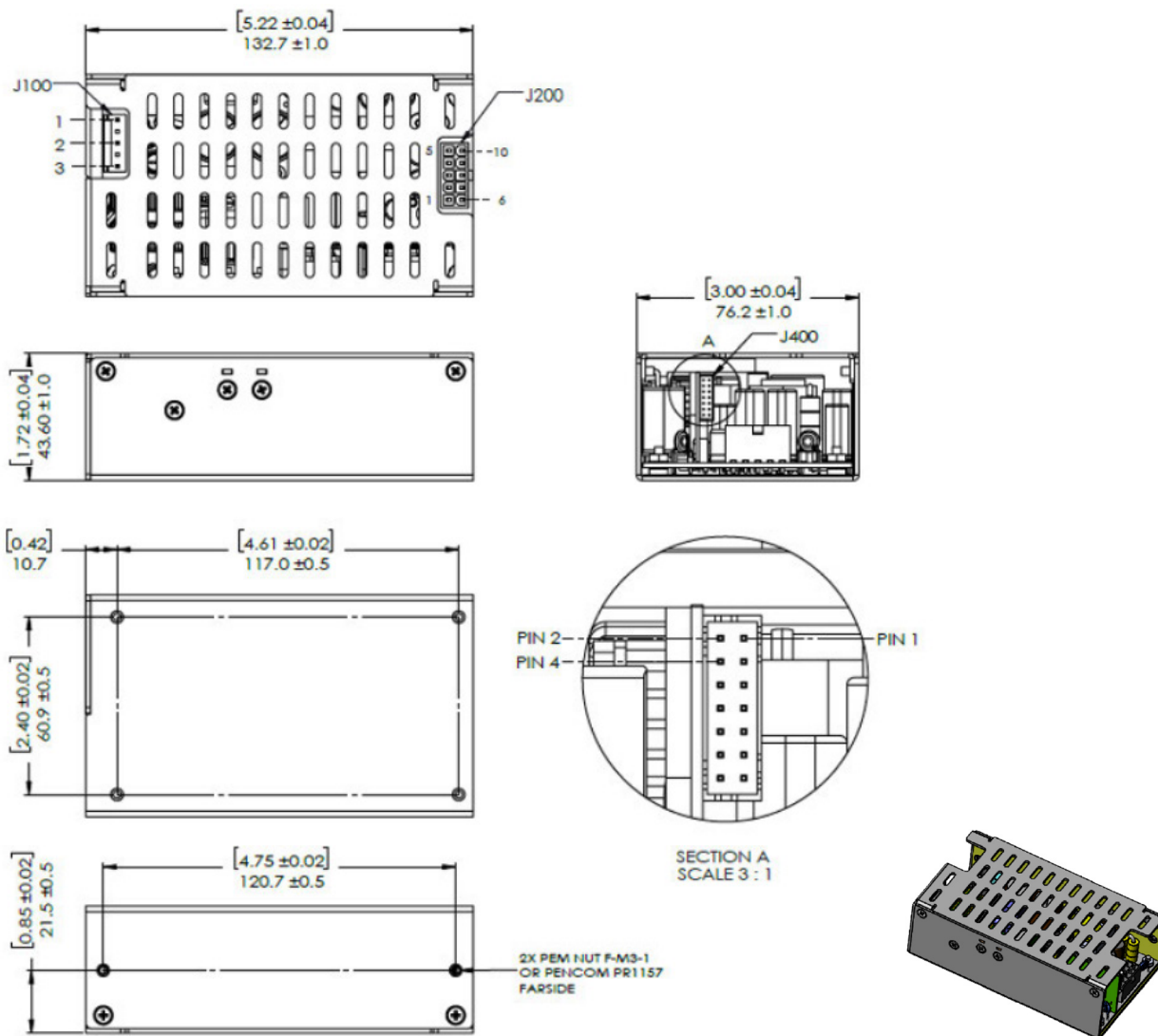

Item	Description
Dimensions	W: 3" x L: 5" x H: 1.5" (W: 76.2mm x L: 127mm x H: 38.1mm)
Unit Weight	490 g
Modification Range	Mounting hole locations, form factor, other specific requirements

PIN ASSIGNMENTS

Connector	Pin Assignment		Mating Connector
J100 (Input connector) - Class I input version TE# 640445-5 5 pin header (2 pins removed)	PIN 1	GND	AMP P/N 640250-5. Pins: 640252-1
	PIN 2	AC Line	
	PIN 3	AC Neutral	
J100 (Input connector) - Class II input version TE# 640445-3 3 pin header (middle pin removed)	PIN 1	AC Line	AMP P/N 640250-3. Pins: 640252-1
	PIN 2	AC Neutral	
J200 (DC output connector) MOLEX# 87427 10 (2x5) pin header	PIN 1	RTN	CviLux: CP-01110020, Pins: P-01100106-HC or Molex 39-01-2105
	PIN 2	RTN	
	PIN 3	RTN	
	PIN 4	+Vo	
	PIN 5	+Vo	
	PIN 6	RTN	
	PIN 7	RTN	
	PIN 8	+Vo	
	PIN 9	+Vo	
	PIN 10	+Vo	
J400 (Signals connector) Landwin# 2052P14S9T 14 pin header	PIN 1	RTN	Landwin: 2050S1400, Pins: 2053T021N or JST PHDR-14VS
	PIN 2	NC	
	PIN 3 ¹	S+	
	PIN 4	RTN	
	PIN 5	NC	
	PIN 6	SMB_Alert	
	PIN 7	NC	
	PIN 8 ²	INHIBIT	
	PIN 9	NC	
	PIN 10	NC	
	PIN 11	RTN	
	PIN 12	NC	
	PIN 13	+5V standby	
	PIN 14	+5V standby	

Notes:
 1. S+: remote sense function of output voltage.
 2. INHIBIT: Logic "High" or "Open" enables and logic "Low" disables main output.
 3. Contact AE for other compatible connector options.

ACCESSORIES

Type	Conditions/Description	Part Number
Cover	IP20 protection cover for self-assembly.	Contact AE
Power supply with cover assembled	Power supply with IP20 protection cover assembled.	NGB425SxxZ-C
Cover with fan	IP20 protection cover with additional fan for self-assembly.	Contact AE
Power supply with cover and fan assembled	Power supply with IP20 protection cover and additional fan, assembled.	Contact AE
Conformal coating	Conformal coating of the power supply of potting.	Contact AE
Custom changes	Any customized requests are subject to feasibility review by AE team.	Contact AE

Note:
 1. Contact AE for custom requirements or modifications requests.

UNIT PACKAGING REQUIREMENTS

Inserted Instructions	Instruction sheet to be provided with all units packaged in individual unit box when used.
Individual Unit Packing	Units can be packed in egg crate type cartons for production quantities. Individual product shipments include an individual unit box.
Master Carton Shipping Box	40 units per master carton. Unit packaged into carton must be protected such that it will sustain 1.4m drop test onto hard surface. Only anti-static packing material may be used inside the box. Exterior box sealing tape is anti-static type. Box size: 40x32x32 cm. Box weight: 22.8 kg.
Individual Carton Packing Box (when used)	Individual carton is labelled with ROHS sticker and individual label showing unit serial number, bar code, manufacturing date, bar code, and manufacturing part number, bar code, country of origin.

PERFORMANCE DATA

Note: Performance data results for NGB425S24K, Class I with 24 V output at 25°C.
Data for other voltages, Class II and other temperatures available upon request.

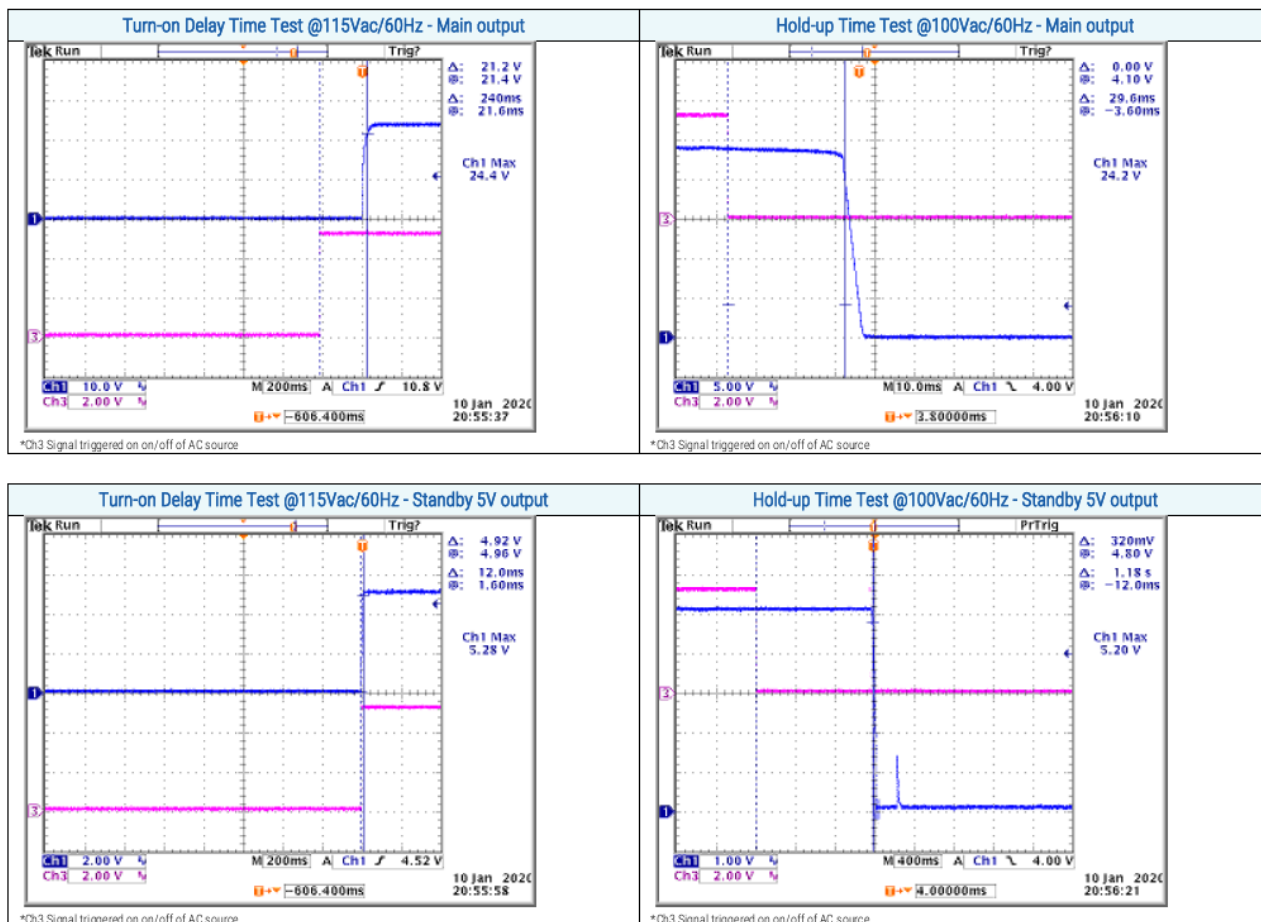

PERFORMANCE DATA

Power Factor

Power Factor Test		
Input Voltage / Frequency	Output load (A)	Measured PF
115 VAC / 60 Hz	17.477	0.986
115 VAC / 60 Hz	13.969	0.983
115 VAC / 60 Hz	10.491	0.978
230 VAC / 50 Hz	17.477	0.970
230 VAC / 50 Hz	13.967	0.966
230 VAC / 50 Hz	6.234	0.920

Efficiency

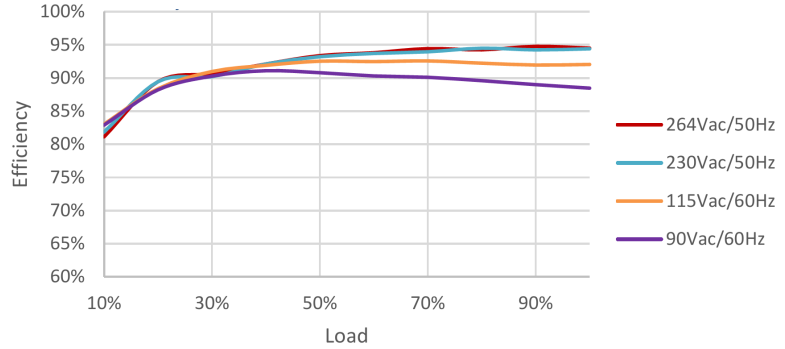

Conducted Emissions Test (CE)

*15 Min warm-up of the power supply was done prior each measurement. Plots below represent test results according to FCC 15 Class B for 120 VAC and EN55032 Class B for 230 VAC. The bottom red limit line shows the -6dB margin to the maximum allowed emissions level according to both FCC 15 and EN55032 standards. Other load conditions available upon request.

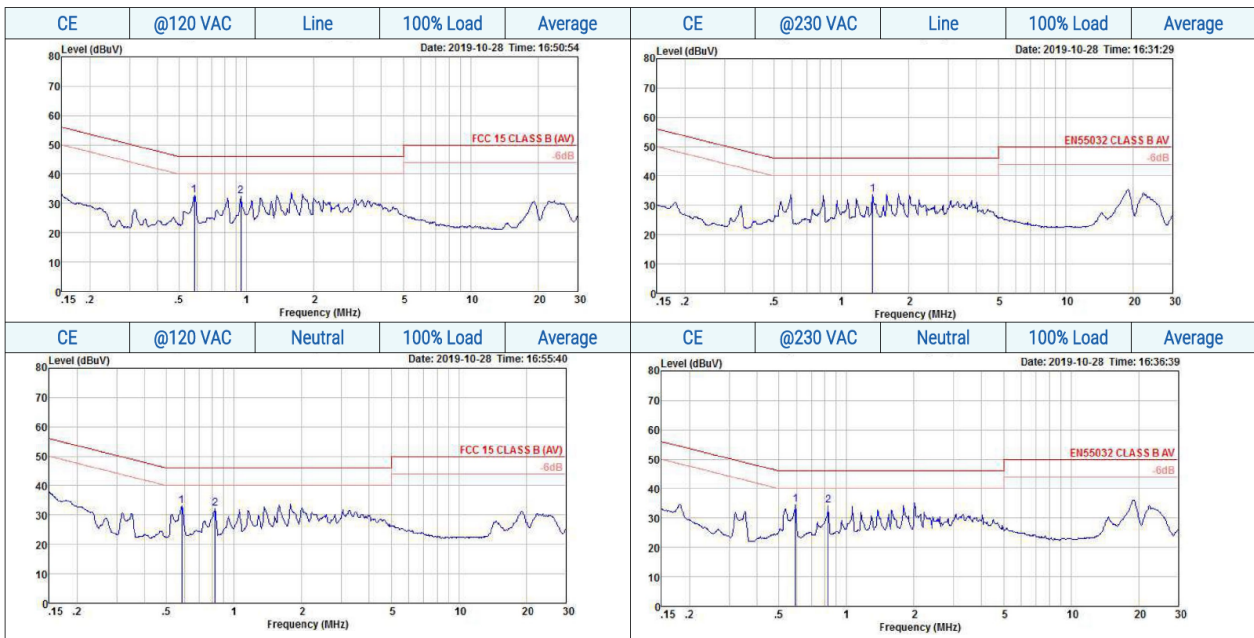

Conducted Emissions Test (CE) CISPR15

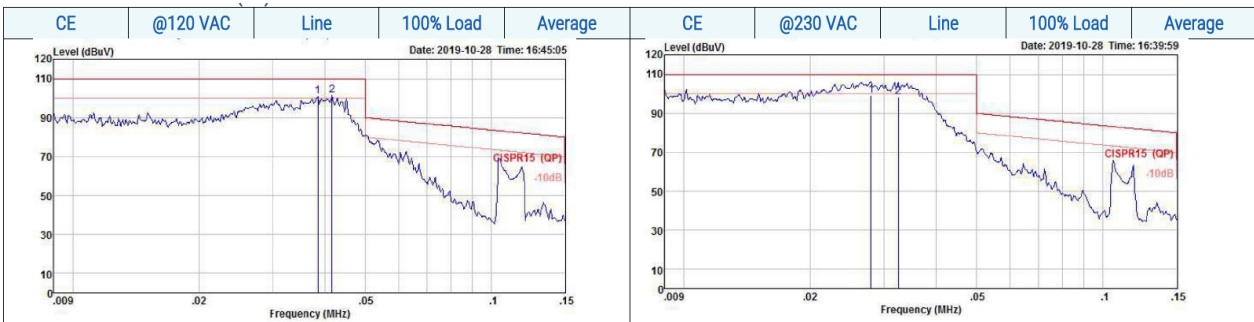

PERFORMANCE DATA

Radiated Emissions Test (RE)

*Plots below represent horizontal and vertical test results at 3 m distance according to FCC part15B Class B for 120 VAC and EN55032 Class B for 230 VAC. The red limit line shows maximum allowed emissions level according to both FCC part 15B and EN55032 standards. Other load conditions available upon request.

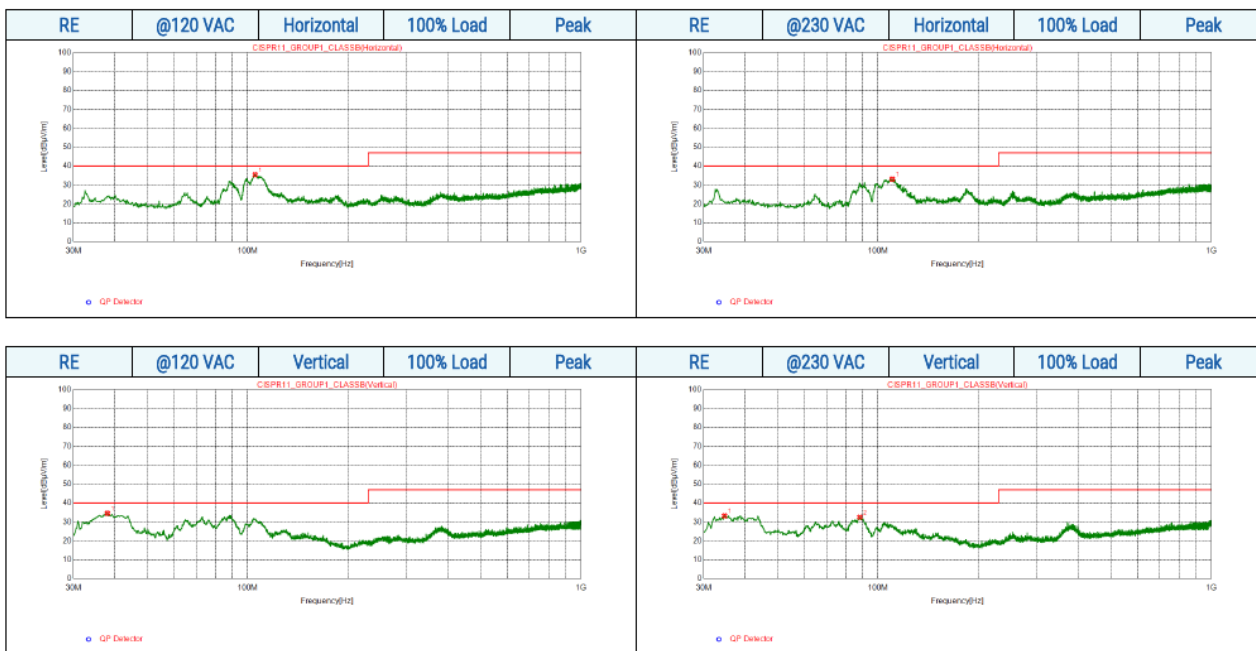

Note:

Conducted and radiated emissions plots show measurements with resistive loads according to the IEC/EN/UL standard’s requirements. EMC performance can be impacted by system level design, integration, or associated connections with additional wires and/or devices. Contact SL Power team for support with system level EMC compliance needs.

THERMAL DATA

The following table lists components of NGB425 series and their maximal allowed temperature (worst case), as confirmed to safety report. Monitoring and keeping these parts below the listed values help to keep the power supply within the given limits by safety agencies:

No.	Description	Hazardous Voltage	Reference Designator	Maximum allowed temperature
1	Electrolytic capacitor (Boost)	Yes	C117	105°C
2	Power transformer	Yes	T200	130°C / 145°C ²
3	Electrolytic capacitor (DC)		C201	105°C
4	Electrolytic capacitor (DC)		C200	105°C
5	Electrolytic capacitor (DC)		C202	105°C
6	Electrolytic capacitor (AUX)		C303	105°C
7	EMI Choke (CM)	Yes	L101	130°C
8	EMI Choke (Pi)	Yes	L103	130°C
9	PFC choke	Yes	L104	130°C
10	LLC Inductor	Yes	L200	130°C
11	PFC boost transistor ¹	Yes	Q104	130°C

Note:

1. Limited access to this component.
2. For IEC/EN 62368-1: 130°C and for IEC/EN 60601-1: 145°C

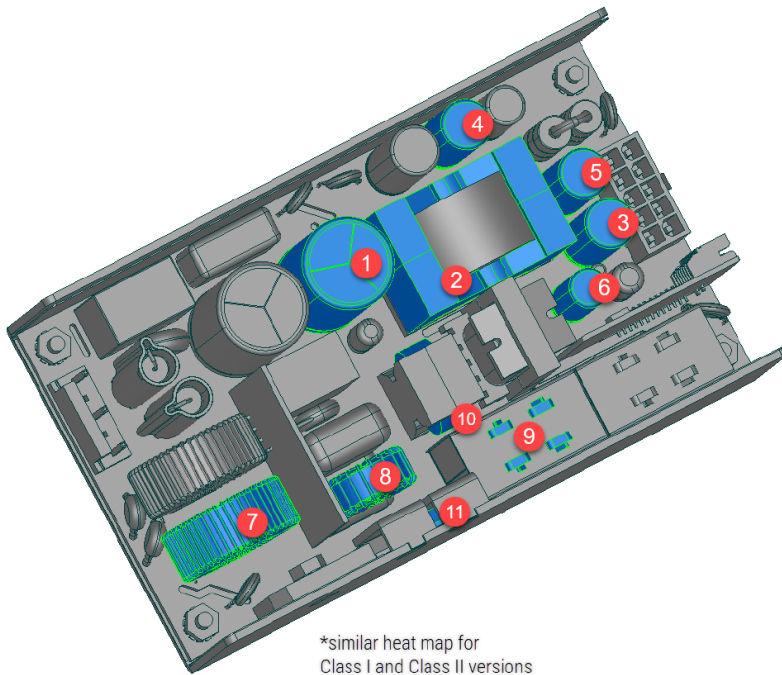

PROPER USE

Thermal Recommendations:

Life of electrolytic capacitors is significantly affected by temperature. It is strongly recommended to keep their temperature 5 to 10°C below the max allowed values in the table under worst case condition especially without active air flow. The reliability of the power supply is affected by higher temperatures as increasing the thermal stress on the components will lead to shorter product life.

Even if power transformer and inductors offer enough thermal margin from maximal allowed temperature, their temperature can reach 130°C and must be considered carefully while placing other system components close to it.

For proper worst-case verification, use low line input voltage 85 VAC 50 or 60Hz with highest load at 40°C. Place thermocouples to listed components on a non-conductive area to measure excessive temperatures and to determine correct system thermal design.

Caution! Some components are located on primary side of AC-DC power supply! Use appropriate safety measures as these components are at hazardous voltage levels. Thermal couples need to be electrically isolated. Only qualified personnel should attempt to make these measurements.

See derating characteristics section for further details.

Installation and Safety:

The power supplies with high power conversion efficiency rely on convection cooling in the surrounding environment (air) to prevent overheating or excessive component temperatures. Therefore, there needs to be adequate access to ambient air to ensure proper thermal performance of the power supply.

Do not exceed the power rating of the product with respect to input voltage and environment temperature of the unit.

The base plate of Class I models is a heat spreader and typically connected to protective earth, it is electrically safe but be aware it may be hot during operation.

The base plate of Class II models is a heat spreader but floating, it is electrically safe but be aware it may be hot during operation.

In some designs the additional heatsinks might not be connected to the base plate. These heatsinks might be electrically connected to components on the hazardous primary side and be at elevated potential with respect to ground. Avoid direct electrical connection between the heat sinks in such case.

The output return of the power supply is by default floating with respect to safety/earth ground (not connected to protective earth).

A non-electrically conductive insulator should be placed between the unit and any conductive surface close to its top or sides to ensure minimal creepage clearance according to the safety standard. If an insulator is not possible, increase these distances to at least 8 mm (0.315") from any components or leads to keep safety clearance.

Use a proper mating connector for connection on the input and output connectors of the power supply. Refer to the connector information.

For better EMI performance avoid cable routing close to power supply especially near magnetics (transformers or inductors) or switching components. If that is not possible, consider shielding cables of the power supply. If improved radiated emissions performance is needed, small ferrite cores can be added to the input or output cable. Contact local SLPE application engineer for support.

If the system requires an additional EMI filter, carefully consider properly choosing system EMI filters. That can make EMI worse if not properly selected.

FEATURES

Power vs. Ambient Temperature

Both Class I and Class II versions of power supplies are capable to provide rated maximum power under airflow. However, at some applications cooling fans are not allowed due to higher IP ratings or where audible noise is a concern. In these systems the design still allow loads up to 70% of maximum rated power in a convection cooled environment up to 50°C. At higher temperatures, refer to the power derating section to avoid activation of the internal Over Temperature Protection (OTP) which shuts down the power supply during excessive temperature excursions. The overtemperature protection is based on an "auto-recovery" principle. See the Proper Use and Thermal Considerations sections of this document.

Class B Conducted and Radiated EMI performance margins

AE understands the difficulties to pass the EMC/EMI tests during the development of any product. The interference with electromagnetic emissions and increasing amount of product with wireless communications makes it difficult more than ever to remain within the targeted EMI margins. Typical power supply is designed to pass EN55032 Class B and FCC part 15 Class B with typical margin of 6db for conducted emissions (CE) and with typical margin of 3db for radiated emissions (RE). The final enclosure of the system might add additional radiation shielding and is dependent on the type of system. See performance data section of this document for CE/RE plots.

Active or Passive Inrush Current Limit

Selected series power supplies are designed with an active circuit to limit inrush current to values as low as 15 A @ 264 VAC. This feature allows the system designers better protection against stressing of components and less risk to trip circuit breakers. A typical design of the power supply is equipped with a passive inrush current limiting peak inrush current to approximately 75 A at a reduce product cost. Contact AE representative to review inrush current modification of any selected product.

FEATURES

Safety and BF Isolation Type Rated

This family complies with BF requirements by providing 2 Means of Patient Protection (2 MOPP) from input to output and 1 MOPP between output and ground to avoid electrical shock for Class I units. All models are CE marked to Low Voltage Directive and approved to AAMI ES/CSA C22.2 No./ IEC 60601-1, 3.1rd Edition. Please contact the application engineering team for CE/UL certificates or CB reports if not found on the SLPOWER.COM website for this product.

BF type isolation is referenced in safety standard IEC 60601-1 to define patient applied part classification. BF means Body Floating which must provide a higher degree of protection against electric shock than that provided by type B applied parts. Systems with type BF applied parts allow patient's body to be at floating electrical potential and complying with the specified requirements of standard IEC60601-1. Due to lower values of allowable leakage current in medical power supplies, it is important to substantially reduce the capacitances that cause leakage currents. Reducing their value can severely reduce the EMI filter's effectiveness.

Operation at Higher Altitude Above Sea Level

For applications at higher sea level the designer should take in account the effect of air pressure on the power supply. SLPE typically designs power supplies that allow to use the units at altitudes up to 5000 m above sea level. This is with respect to air clearance between the components on the PCB following the multiplication factor as described in IEC 60601-1 8.9.1.5 – ME Equipment rated for high altitudes. However, considering the thermal performance of the power supply at altitudes above 2000 m the cooling efficiency drops due to lower air density. Paschen's law explains this effect in more detail: https://en.wikipedia.org/wiki/Paschen%27s_law. Whether natural convection or active airflow, the dissipated heat transfer from power supply is less effective at higher altitudes and must be considered.

Designed to Meet IEC 60601-1-2 4th Edition EMC requirements

The 4th edition of standard IEC60601-1-2 for EMC requirements was released for NA and EU. Most significant change of the standard is harmonization with IEC60601-1-11 to classify medical devices into three main groups, professional healthcare facility environment, home healthcare environment which is more stringent and desires more attention of system designers and special environment.

It is important to note that IEC 60601-1-2 4th edition, is the EMC standard and not to be confused with safety standard IEC 60601-1 3rd edition. While a system must be approved to IEC 60601-1-2 standard a power supply is just part of it therefore certification is given at the system level. However, as some of the tests are directly related to functionality of the power supply, its design takes into consideration the IEC 60601-1-2, 4th Edition EMC requirements.

Output Ripple and Noise

Typical output noise and ripple limits are defined to 1% of the output voltage. Noise measurements are made with noise probe directly at the end of 15cm twisted pair wires terminated with a 0.1 uF ceramic and 10 uF electrolytic low ESR capacitors. Use a short tip oscilloscope voltage probe when making the measurement. This is required to eliminate measurement error due to impedance imbalance errors introduced by the scope probe ground lead length. Values will be higher at ambient temperatures below 0°C. Consult the product datasheet prior to assessing the output ripple and noise measurement results.

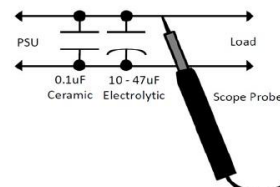

Common Mode Noise

Common mode noise is electrical signal that appears between either output and earth ground or chassis ground. This comes about due to parasitic capacitance and inductive coupling in the power supply that couples electrical energy from the primary to the secondary or from the secondary to earth ground. Although the coupling is minimized by design and construction, it cannot easily be eliminated. Be aware of any special needs in the application for low common mode noise.

Load and Noise Filtering Capacitors

The power supply is equipped with output filtering capacitors to minimize the switching frequency voltage ripple and noise that is an artifact of the switching power conversion process. However, additional end load capacitance may be needed depending on the application. With electronic circuitry as the load, it is recommended to add ceramic capacitors (0.1 to 1uF) for noise spike reduction and electrolytic capacitor for ripple reduction and transient response voltage dip reductions. The amount of voltage dip during a transient is a function of the load step amplitude and rise/fall time of the load.

Premium Electrolytic-Capacitors / Reliability and Robustness

Lifetime of the power supply is mostly dependent on life limiting components such as electrolytic capacitors. This is particularly the case for convection cooled applications. AC ripple currents in these capacitors create additional heat, but the main cause of temperature rise is from adjacent heat sources. The higher the long-term temperature of the electrolytic capacitors, the shorter the life of the capacitor. SLB300 series are designed to keep the temperature of critical electrolytic capacitors as low as possible below the maximum allowed limits but also fitted with premium electrolytic capacitors to benefit from best technologies of capacitor manufacturers. This approach allows SLB300 life cycle of over 10 years in standard business use conditions at ambient temperature of 25°C. Thermal consideration section of this application note lists maximum allowed temperatures of critical electrolytic capacitors and components.

TERMINOLOGY & DEFINITIONS

IEC

The IEC (International Electrotechnical Commission) is an international body that sets safety standards for the electrotechnology space. The Class I and Class II input designations refer to the internal construction and electrical insulation of a power supply. These standards were developed to protect the user from electric shock.

Class I / II / III

IEC Class I input models have basic insulation and must incorporate a protective earth (ground) connection to mitigate the risk of electric shock. Class I input power supplies have a 3-pin input, line (L), neutral (N) and ground (PE or FG).

IEC Class II input models feature additional safety precautions such as double insulation or reinforced insulation, thereby eliminating the need for a protective earth (ground) connection. Class II input power supplies have a 2-pin input, line (L) and neutral (N).

IEC Class III equipment is defined in some standards where protection against electrical shock relies on the voltage being less than 60 VDC of 42.4Vac_{pk} referred to as Safety Extra Low Voltage (SELV). Generally, these are battery power or power from a SELV power source.

Type B, Type BF, Type CF applied parts

Applied Part – Part of the medical equipment designed to or likely to physically contact the patient.

Type B (Body) applied part - Not suitable for direct cardiac applications.

Type BF (Body Floating) applied part - A higher degree of protection, not suitable for direct cardiac applications.

Type CF (Cardiac Floating) applied part -The highest degree of protection, suitable for direct cardiac applications.

Leakage Current, Patient Leakage Current

Leakage current is the current that flows through the protective ground conductor to ground. In the absence of a grounding connection, it is the current that could flow from any conductive part or the surface of non-conductive parts to ground if a conductive path was available such as a human body.

Earth Leakage Current: Is the current that flows through the ground conductor of the line cord back to the ground.

Enclosure Leakage Current: Is the current that flows from any part of the enclosure through a person and back to ground is touched by a person.

Patient Leakage Current: applies to medical devices and is the current that flows through a person to ground having an applied part by applying an unintended voltage from an external source.

Single Fault Condition, Normal Condition

Safety standards dictate the requirements for products to remain safe during the normal operating condition (NC) of the product as well as during an abnormal single fault condition (SFC). Examples for SFC are insulation short circuit, open circuit of protective earth or interruption of any one supply conductor.

Isolation and HI-POT

All of the world's safety agencies require a Dielectric Withstanding Voltage test (also known as a HI-POT or Electric Strength test). This test is used to determine the adequacy of the equipment's insulation mechanisms to protect against electrical shock. The HI-POT test is a test of the insulation surrounding the primary circuits. It involves the application of a high voltage from the primary circuit to the grounding (earth) circuit and to the low-voltage secondary circuits. The potential used for each test is pre-determined by the applicable safety standard. It is based on the AC input voltage, the grade of insulation used in the equipment and the accessibility of the secondary voltages.

Continuous Operation vs. Peak Power

The typical applications can be divided to at least three main categories of power requirements. The first would be a system with electromechanical components like motors or pumps. Such devices require nominal power for standard operation and higher power for the initial movements. The momentum of the motor or pump often requires significantly higher input current which can trigger the over current protection if the power supply was not selected properly. The second category is the battery charger with the maximum power required for empty battery state and low to medium power requirement for others. In such systems the designer considers the average power requirement and calculates the time for the thermal relaxation period in case of empty battery where the power supply is required to provide maximum power at the beginning and then decrease slowly till the battery is completely charged. In both these categories the power supply dimension is depending on average or peak power requirements. The other category covers power supply designs for continuous operations in which the rated power is required for long period of time.

TERMINOLOGY & DEFINITIONS

Grounding

A power supply can have three types of accessible grounds. Each of these ground connections has dedicated purpose to maintain within safety requirements or electrical characteristics stated in datasheet. Do not mix usage of these electrical contacts.

Functional Ground (FG) also marked as GROUND on AC input. The enclosure of power supply is directly connected to this electrical potential. Floating FG of the power supply may affect electromagnetic characteristics of the unit.

Protective Earth (PE) marked as GROUND on AC input. Same as FG, the enclosure of power supply is directly connected to this electrical potential. While FG is mainly used to improve the EMI performance of the power supply, PE connection requires in addition safety relevant compliance like maximum permissive PE resistance or minimum current conductivity of several amps defined by safety and in different regions worldwide.

Output Return marked as (-) on DC output. Isolated from AC input, rated as SELV. This electrical potential is floating with respect to protective earth.

Signal return marked as GND on the signal connectors. This electrical potential is a reference voltage for digital signals and control features on the power supply such as 5V standby, DC_OK, AUX, ACI, VCI etc.. Shorting of this node to other ground may feed common mode noise into the control system and distort the functionality of digital control or feedback loop.

Primary and Secondary Circuit of a Power Supply

The input part of the power supply is the so-called front-end block or primary side. It contains a rectification stage and an active power factor correction stage to minimize AC mains current distortion and generate a stable energy storage point for further power conversion. This is the block to look at for wide input AC voltage range along with good power factor correction, low harmonics distortions and high efficiency. The controller on the primary side of AC-DC power supply monitors voltage and current changes depending on network and load condition and control power switching devices as part of the power conversion process. This block is hazardous for potential electrical shock. Specific safety standards such as 60601-1 or 62368-1 usually require the output voltage to be isolated from hazardous electrical circuits. This type of protection is achieved by adhering to creepage and clearance distances between primary front-end circuitry and secondary output circuitry after the isolation circuitry of the power supply. By controlling the switching frequency or pulse width of power devices across the transformer, while using several techniques, the isolated DC-DC conversion allows power transmission to the load.

IEC/EN/CSA/ANSI/AAMI ES60601-1, 3rd Edition, Amendment 1

To govern the design of medical equipment, the International Electrotechnical Committee (IEC) has produced a standard to control all aspects of safety directly or indirectly relating to the handling, use or connection to, of medical equipment. This standard is referenced as IEC 60601, or simply referred to as IEC 601.

IEC61010-1

Safety Requirements for Electrical Equipment for Measurement, Control, and Laboratory Use.

UL8750

Safety Standard for LED Lighting. The standard covers LED equipment that is part of a luminaire or other lighting equipment operating in the visible light spectrum.

Class 2, UL1310

These requirements cover indoor and outdoor use for Class 2 power supplies, LED drivers, and battery chargers. The UL1310, Class 2 standard sets limits on the source with limited voltage and energy capacity.

Certified Body Scheme (CB Report)

The CB Scheme is a vast international arrangement established by the International Electrotechnical Commission (IEC) for mutual acceptance of safety test reports among participating certification organizations in the field of electrical and electronic equipment.

UL94 Enclosure Flame Rating

HB: Slow-burning on a horizontal specimen; burning rate < 76 mm/min for thickness < 3 mm or burning stops before 100 mm.

V-2: Burning stops within 30 seconds on a vertical specimen; drips of flaming particles are allowed.

V-1: Burning stops within 30 seconds on a vertical specimen; drips of particles allowed as long as they are not inflamed.

V-0: Burning stops within 10 seconds on a vertical specimen; drips of particles allowed as long as they are not inflamed.

Insulation and Isolation

Operational/Functional: Insulation for correct operation of equipment.

Basic Insulation: Insulation to provide basic protection against electric shock.

Supplementary Insulation: Independent insulation applied in addition to basic insulation to ensure protection against electric shock in the case of a failure of basic insulation.

Double Insulation: Insulation that includes both basic and supplementary insulation.

Reinforced Insulation: Provides a single insulation system that offers a degree of protection against electric shock equivalent to double insulation.

TERMINOLOGY & DEFINITIONS

IEC61000-4-x Acceptance Criteria

The test results for the various sections of the EN61000-4 Standards are classified in terms of the loss of functionality or degradation of performance of the equipment under test (EUT), relative to a performance level defined by its manufacturer, the requestor of the test, or agreed upon between the manufacturer and the purchaser of the product. The recommended classifications apply to all sections of the standard detailed herein, and are as follows:

Criteria A: Normal performance within limits specified by the manufacturer, requestor, or purchaser.

Criteria B: Temporary loss of functionality or degradation of performance which ceases after the disturbance is removed, and from which the EUT recovers its normal performance without operator intervention.

Criteria C: Temporary loss of functionality or degradation of performance, the correction of which requires operator intervention.

Criteria D: Loss of functionality or degradation of performance which is not recoverable, owing to damage to hardware or software, or loss of data.



For international contact information,
visit advancedenergy.com.

powersales@aei.com (Sales Support)
productsupport.ep@aei.com (Technical Support)
+1 888 412 7832

ABOUT ADVANCED ENERGY

Advanced Energy (AE) has devoted more than four decades to perfecting power for its global customers. AE designs and manufactures highly engineered, precision power conversion, measurement and control solutions for mission-critical applications and processes.

Our products enable customer innovation in complex applications for a wide range of industries including semiconductor equipment, industrial, manufacturing, telecommunications, data center computing, and medical. With deep applications know-how and responsive service and support across the globe, we build collaborative partnerships to meet rapid technological developments, propel growth for our customers, and innovate the future of power.

PRECISION | POWER | PERFORMANCE | TRUST

Specifications are subject to change without notice. Not responsible for errors or omissions. ©2026 Advanced Energy Industries, Inc. All rights reserved. Advanced Energy®, and AE® are U.S. trademarks of Advanced Energy Industries, Inc.