

ARTESYN CSU2000ADC

2000 Watts Distributed Power System



PRODUCT DESCRIPTION

Advanced Energy's Artesyn CSU2000ADC is housed in the industry standard 1U x 73.5 x 185 mm form factor featuring -48 Vdc input voltage. This DC/DC power supply belongs to the CRPS family of products, and matches the mechanical form and fit of Advanced Energy's AC/DC power supplies. The common form, fit, and function for all products in the family provides a path for power capacity flexibility, future-proofing your system designs.

SPECIAL FEATURES

- 2000 W output power
- High power and short form factor
- 1U power supply
- High density design: 62 W/in³
- Uses two-hole terminal lugs to handle high input current
- Inrush current control
- N+M redundant N+M ≤ 4
- Hot-pluggable
- Active current sharing
- Full digital control
- PMBus® compliant
- Accurate input power reporting
- Compatible with Artesyn's Universal PMBus GUI
- Reverse airflow option

COMPLIANCE

- Conducted/Radiated EMI Class A

SAFETY

- IEC 60950, IEC 62368
- UL/cUL/CSA62368-1
- UL + CB Report
- CQC
- KC
- BIS
- CE Mark
- UKCA Mark

TARGET APPLICATIONS

- Server and Storage
- Networking

AT A GLANCE

Total Power

2000 Watts

Input Voltage

-40 to -72 Vdc

of Outputs

Main and Standby



MODEL NUMBERS

Standard	Input Voltage	Output Voltage	Minimum Load ¹	Maximum Load	Stand-By Supply	Air Flow Direction
CSU2000ADC-3-100	-40 to -72Vdc	12.2Vdc	1A	163.9A	12.0Vdc@3.5A	Normal (Output to Input)
CSU2000ADC-3-101	-40 to -72Vdc	12.2Vdc	1A	163.9A	12.0Vdc@3.5A	Reverse (Input to Output)

Note 1 - 1A minimum current for transient load response testing only. Unit is designed to operate and be within output regulation range at zero load.

Options

None

ELECTRICAL SPECIFICATIONS

Absolute Maximum Ratings

Stress in excess of those listed in the “Absolute Maximum Ratings” may cause permanent damage to the power supply. These are stress ratings only and functional operation of the unit is not implied at these or any other conditions above those given in the operational sections of this TRN. Exposure to any absolute maximum rated condition for extended periods may adversely affect the power supply’s reliability.

Table 1. Absolute Maximum Ratings ⁵						
Parameter	Models	Symbol	Min	Typ	Max	Unit
Input Voltage DC continuous operation	All models	$V_{IN,DC}$	-40	-	-72	Vdc
Maximum Output Power	All models	$P_{O,max}$	-	-	2000	W
Isolation Voltage Input to output Input to safety ground	All models All models		- -	- -	1500 1500	Vdc Vdc
Ambient Operating Temperature ¹	CSU2000ADC-3-100 CSU2000ADC-3-101	T_A	-5 -5	- -	65 50	°C
Storage Temperature	All models	T_{STG}	-40	-	70	°C
Humidity (non-condensing) Operating Non-operating	All models All models		5 5	- -	95 95	% %
Altitude Operating Non-operating	All models All models		- -	- -	5000 10000	Meters Meters
MTBF ²	All models		500	-	-	KHours
Operating Life ³	All models		5	-	-	Years
E-cap Life ³	All models		43.8	-	-	KHours
Fan L10 Life ⁴	All models		45	-	-	KHours

Note 1 - -5°C to 55°C full rated power and derated power from 55°C to 65°C for CSU2000ADC-3-100.

-5°C to 40°C full rated power and derated power from 40°C to 50°C for CSU2000ADC-3-101.

Note 2 - It is calculated under 50°C ambient temperature (40°C for reverse air), typical input and 100% $I_{O,max}$.

Note 3 - It is calculated under 50°C ambient temperature (40°C for reverse air) and 85% $I_{O,max}$ sea level.

Note 4 - It is calculated under 40°C ambient temperature.

Note 5 - No damage when subjected to input transient impulse voltage levels as stated in ATIS 0600315.

ELECTRICAL SPECIFICATIONS

Input Specifications

Table 2. Input Specifications						
Parameter	Condition	Symbol	Min	Typ	Max	Unit
Operating Input Voltage, DC	All	$V_{IN,DC}$	-40		-72	Vdc
Regulatory Label for Input Operating Range ¹	All	$V_{IN,DC}$	-	-48 ~ -60	-	Vdc
Maximum Input Current ($I_O = I_{O,max}$, $I_{SB} = I_{SB,max}$)	$V_{IN,DC} = -40Vdc$	$I_{IN,max}$	-	-	65	A
	$V_{IN,DC} = -48Vdc$		-	-	60	A
	$V_{IN,DC} = -53Vdc$		-	-	55	A
	$V_{IN,DC} = -60Vdc$		-	-	48	A
No Load Input Current ($V_O = On$, $I_O = 0A$, $I_{SB} = 0A$)	$V_{IN,DC} = -40Vdc$	$I_{IN,no-load}$	-	315	-	mA
	$V_{IN,DC} = -72Vdc$		-	155	-	mA
No Load Input Power ($V_O = On$, $I_O = 0A$, $I_{SB} = 0A$)	$V_{IN,DC} = -40Vdc$	$P_{IN,no-load}$	-	12	-	W
	$V_{IN,DC} = -72Vdc$		-	11	-	W
Standby Input Current ($V_O = Off$, $I_{SB} = 0A$)	$V_{IN,DC} = -40Vdc$	$I_{IN,standby}$	-	200	-	mA
	$V_{IN,DC} = -72Vdc$		-	105	-	mA
Standby Input Power ($V_O = Off$, $I_{SB} = 0A$)	$V_{IN,DC} = -40Vdc$	$P_{IN,standby}$	-	8	-	W
	$V_{IN,DC} = -72Vdc$		-	7	-	W
Startup Surge Current (Inrush) ²	ETSI 300 132-2	I_t/I_m	-	-	48	-
Input Fuse	Internal, SMD, 100A, 100Vdc		-	-	100	A
Turn-on Voltage Minimum of 1V hysteresis	DC Input	$V_{IN,DC}$	-	-39	-	Vdc
Turn-off Voltage Minimum of 1V hysteresis	DC Input	$V_{IN,DC}$	-	-38	-	Vdc
Switching Frequency (with 3-phase interleave)	Boost DC-DC		-	90	-	KHz
			-	150	-	KHz
Operating Efficiency @ 25°C	$V_{IN,DC} = 53Vdc$ $I_O = 10\%I_{O,max}$ $I_O = 20\%I_{O,max}$ $I_O = 50\%I_{O,max}$ $I_O = 100\%I_{O,max}$	η	87	-	-	%
			91	-	-	%
			94	-	-	%
			91	-	-	%
System Stability Phase Margin Gain Margin			45	-	-	°
			-6	-	-	dB

Note 1 - Nominal range is the safety label rating.

Note 2 - I_t inrush current is the magnitude of the instantaneous value. I_m is the maximum steady state input current at the nominal voltage -53Vdc.

The ratio of the instantaneous inrush current to the maximum steady state current should not exceed the limits when input is first applied to the power supply.

ELECTRICAL SPECIFICATIONS

Output Specifications

Table 3. Output Specifications						
Parameter	Condition	Symbol	Min	Typ	Max	Unit
Factory Set Output Voltage	Measured at the output mating connector at 50% load, room temperature, nominal input voltage	V_O	12.18	12.20	12.22	V
		V_{SB}	11.70	12.00	12.30	
Output Regulation - Static	Inclusive of set-point, temperature change, warm-up drift and static load	V_O	11.80	12.20	12.60	V
		V_{SB}	11.40	12.00	12.60	
Output Regulation - Total	Inclusive of set-point, temperature change, warm-up drift and dynamic load	V_O	-5	-	5	%
		V_{SB}	-5	-	5	
Output Ripple, pk-pk	Measured with a 0.1 μ F ceramic capacitor in parallel with a 10 μ F tantalum capacitor, 10 to 20MHz bandwidth	V_O	-	-	120	mV _{PK-PK}
		V_{SB}	-	-	120	
Output Current ^(1,2)	All	I_O	0	-	163.9	A
		I_{SB}	0	-	3.5	
Main Output Current Share Accuracy	25% to 100% $I_{O,max}$	% I_O	-	-	6	%
Number of Parallel Units	Main output current share connected		-	-	4	Units
Load Capacitance	Main output cold redundancy and dynamic load	C_O	2000	-	-	μ F
	Main output start up and stability	C_O	-	-	50000	
	Main output peak current	C_O	18000	-	-	
	Standby output	C_{SB}	47	-	3100	
V_O Dynamic Response ³	60% load change, slew rate = 0.5A/ μ s	V_O t_s	11.6 -	- 0.5	12.8 -	V mSec
	Peak Deviation Settling Time 1A load change, slew rate = 0.5A/ μ s	V_{SB} t_s	11.4 -	- 0.5	12.6 -	V mSec

Note 1 - Permissible overload of up to 267A under short-term conditions. See over-current protection section.

Note 2 - 1A Minimum current for transient load response testing only. Unit is designed to operate and be within output regulation range at zero load.

Note 3 - Load changes from minimum to maximum or maximum to minimum may cause output voltage to go out of regulation but will not cause the power supply to shut down. Minimum allowable output capacitance applies. The starting current is 1A.

ELECTRICAL SPECIFICATIONS

System Timing Specifications

Table 4. System Timing Specifications					
Label	Parameter	Min	Typ	Max	Unit
T1 ¹	Delay from DC being applied to 12V standby output being within regulation.	-	-	1500	mSec
T2	Delay from DC being applied to all output voltages being within regulation.	-	-	3000	mSec
T3	Output voltage rise time for 12V from 10% to within regulation limits, the same for standby output.	10	-	70	mSec
T4	Delay from output voltages within regulation limits to PWOK asserted high at turn on.	100	-	500	mSec
T5	Delay from loss of DC to de-assertion of PWOK.	1	-	-	mSec
T6	Delay from PWOK de-asserted to output voltages dropping out of regulation limits.	1	-	-	mSec
T7	Hold up time - time output voltage stays within regulation after the loss of DC.	2.4	-	-	mSec
T8	Delay from standby voltage in regulation to output voltage in regulation at DC turn on.	50	-	1000	mSec
T9	Duration of PWOK being in the de-asserted state during an off/on cycle using DC or the PSON signal.	100	-	-	mSec
T10	Delay from PSON active to output voltages within regulation limits.	5	-	400	mSec
T11	Delay from PSON deactive to power supply turning off.	-	-	5	mSec
T12	Hold up time - time standby voltage stays within regulation after the loss of DC. Measured at 70% load with standby output loaded at 1.75A.	50	-	-	mSec
T13	Delay from input being applied to VIN_GOOD assertion.	-	-	1800	mSec
T14	Delay from loss of DC to de-assertion of VIN_GOOD.	-	-	2	mSec
T15	This is the time the PSU must stay off when being powered off with loss of DC input. Both outputs must meet this off time: 1) Whenever PWOK is de-asserted for the 12V main output; 2) Whenever the 12V standby output drops below regulation limits.	500	-	-	mSec

Note 1 - 1500mSec for first time startup, 2500mSec for other condition.

ELECTRICAL SPECIFICATIONS

System Timing Diagram

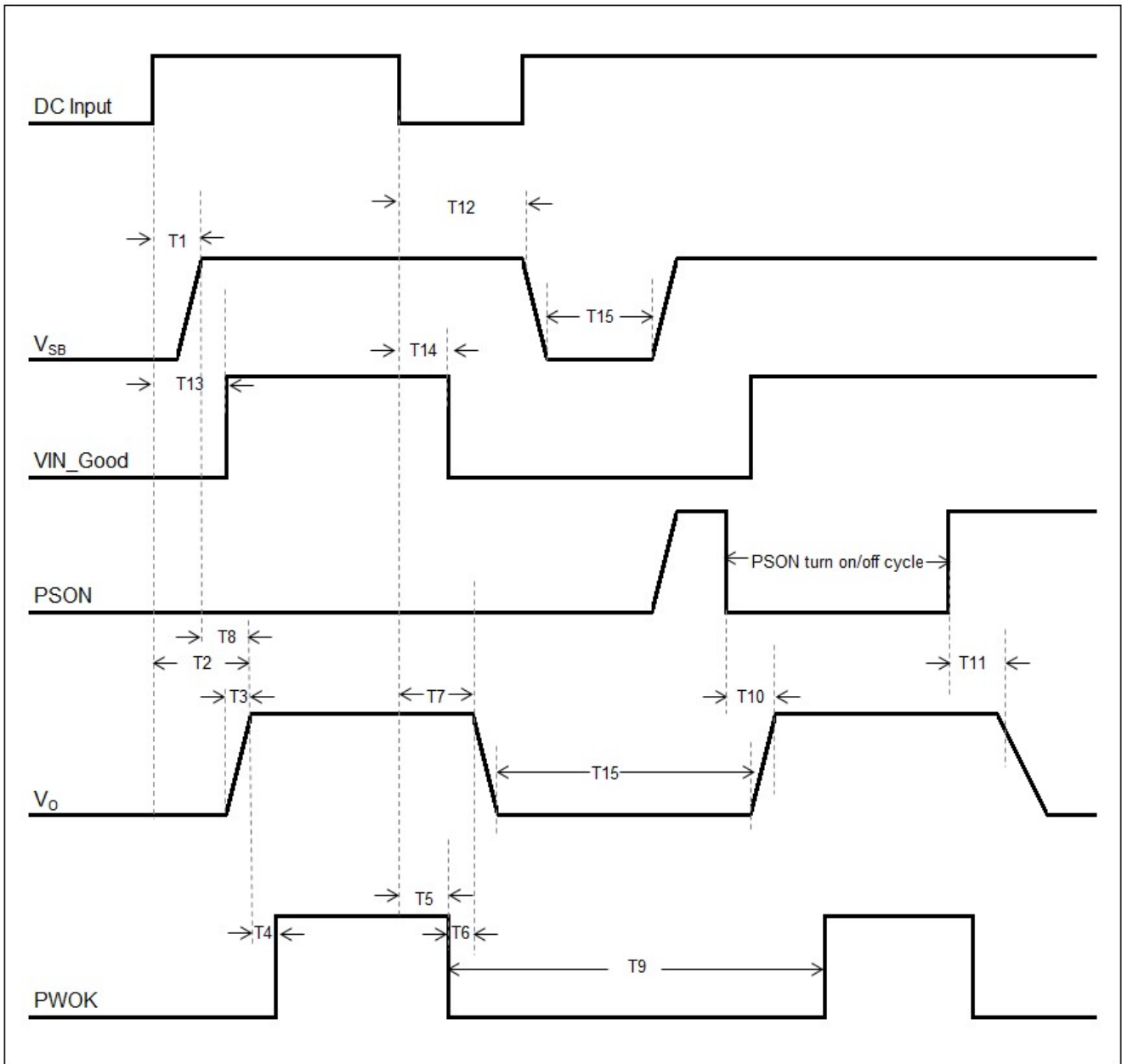

ELECTRICAL SPECIFICATIONS

CSU2000ADC-3-100 Performance Curves

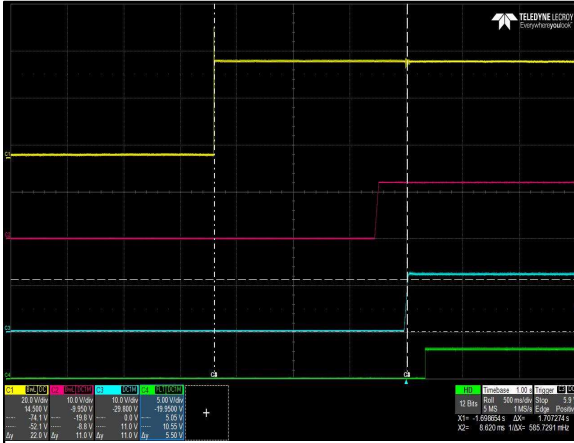

Figure 1: CSU2000ADC-3-100 Turn-On Delay via DC input
 Vin = -40Vdc Load: $I_O = 163.9A$ $I_{SB} = 3.5A$
 Ch 1: V_{IN} Ch 2: V_{SB} Ch 3: V_O Ch 4: PWOK

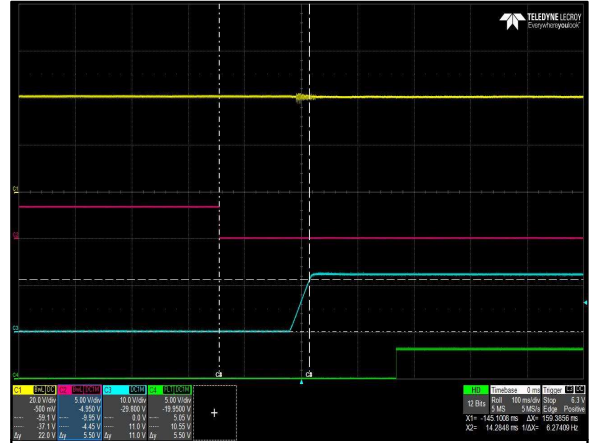

Figure 2: CSU2000ADC-3-100 Turn-On Delay via PSON
 Vin = -40Vdc Load: $I_O = 163.9A$ $I_{SB} = 3.5A$
 Ch 1: V_{IN} Ch 2: PSON Ch 3: V_O Ch 4: PWOK



Figure 3: CSU2000ADC-3-100 Hold-Up Time
 Vin = -40Vdc Load: $I_O = 163.9A$ $I_{SB} = 3.5A$
 Ch 1: V_{IN} Ch 2: V_{SB} Ch 3: V_O Ch 4: PWOK

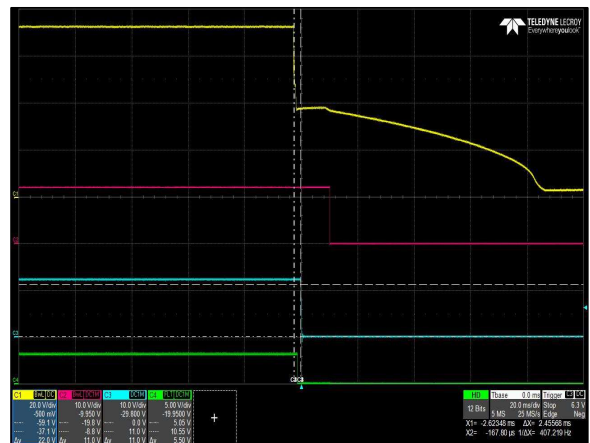

Figure 4: CSU2000ADC-3-100 Hold-Up Time
 Vin = -72Vdc Load: $I_O = 163.9A$ $I_{SB} = 3.5A$
 Ch 1: V_{IN} Ch 2: V_{SB} Ch 3: V_O Ch 4: PWOK

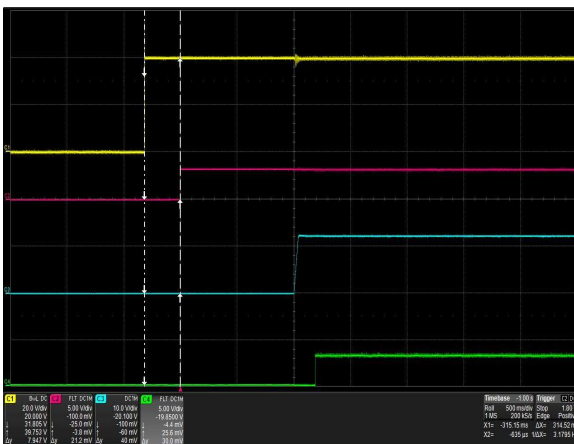

Figure 5: CSU2000ADC-3-100 VIN_GOOD Assert Characteristic
 Vin = -40Vdc Load: $I_O = 10A$ $I_{SB} = 1A$
 Ch 1: V_{IN} Ch 2: VIN_GOOD Ch 3: V_O Ch 4: PWOK

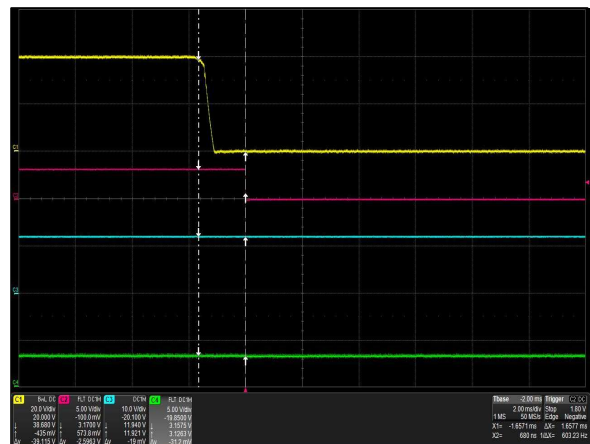

Figure 6: CSU2000ADC-3-100 VIN_GOOD De-assert Characteristic
 Vin = -40Vdc Load: $I_O = 10A$ $I_{SB} = 1A$
 Ch 1: V_{IN} Ch 2: VIN_GOOD Ch 3: V_O Ch 4: PWOK

ELECTRICAL SPECIFICATIONS

CSU2000ADC-3-100 Performance Curves

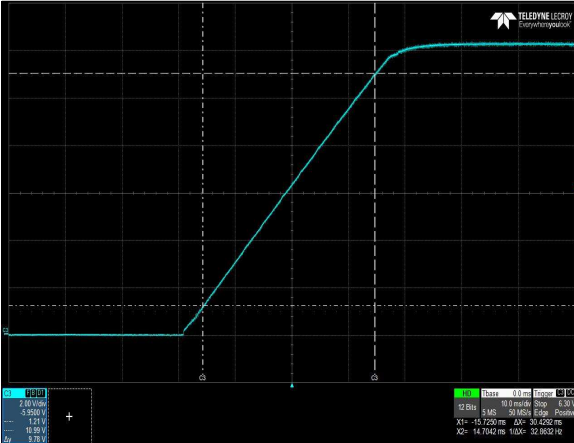

Figure 7: CSU2000ADC-3-100 Output Voltage Startup Characteristic
 Vin = -40Vdc Load: I_O = 163.9A
 Ch 1: V_O

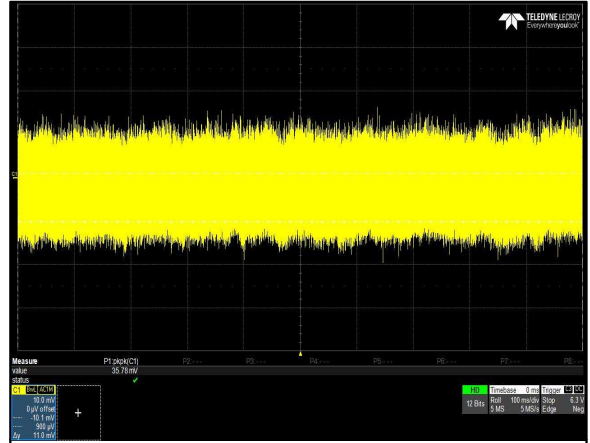

Figure 8: CSU2000ADC-3-100 Ripple and Noise Measurement
 Vin = -48Vdc Load: I_O = 163.9A I_{SB} = 3.5A
 Ch 1: V_O



Figure 9: CSU2000ADC-3-100 Turn Off Characteristic via PS_ON
 Vin = -48Vdc Load: I_O = 163.9A I_{SB} = 3.5A
 Ch 2: PS_ON Ch 3: V_O Ch 4: PWOK

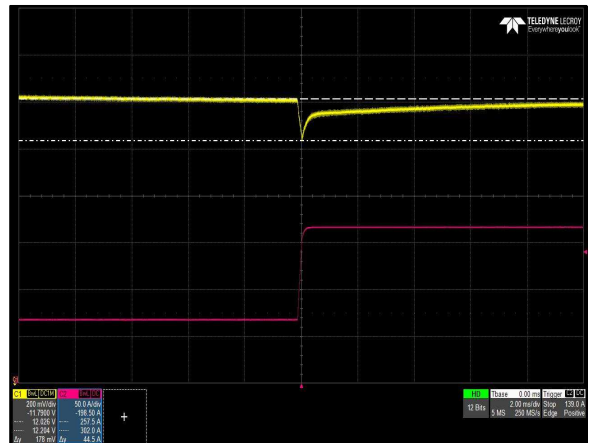

Figure 10: CSU2000ADC-3-100 Transient Response - V_O Deviation
 40% to 100% load change, 0.5A/μs slew rate, Vin = -48Vdc
 Ch 1: V_O Ch 2: I_O

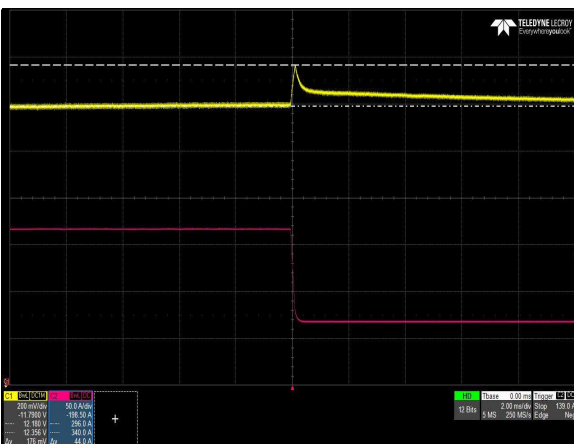

Figure 11: CSU2000ADC-3-100 Transient Response - V_O Deviation
 100% to 40% load change, 0.5A/μs slew rate, Vin = -48Vdc
 Ch 1: V_O Ch 2: I_O

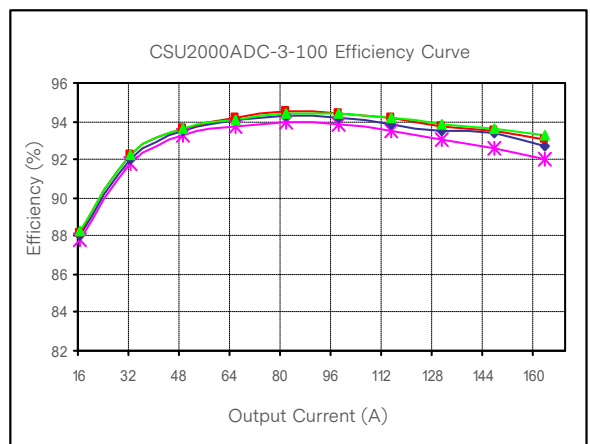

Figure 12: CSU2000ADC-3-100 Efficiency Curve @ 25°C
 Loading: I_{O,max} = 10% increment to I_{O,max}

ELECTRICAL SPECIFICATIONS

Protection Function Specifications

Input Fuse

CSU2000ADC series power supply is equipped with an internal non user serviceable 100A, 100Vdc fuse for fault protection.

Over Voltage Protection (OVP)

The power supply latches off during output overvoltage with the input recycling or PSON to reset the latch. +12V V_{SB} overvoltage protection is also latch mode.

Parameter	Min	Nom	Max	Unit
Main Output Overvoltage	-	-	14.5	V
Standby Output Overvoltage	-	-	14.5	V

Short Circuit Protection (SCP)

The power supply withstands a continuous short circuit with no permanent damage, applied to its main output during start-up or while running. A short is defined as impedance less than 0.04 ohms or less.

When the standby output V_{SB} is shorted the output will go into “hiccup mode”. When the V_{SB} attempts to restart, the maximum peak current from the V_{SB} output will be less than 10.0A.

Over Temperature Protection (OTP)

The power supply is internally protected against over temperature conditions. When the OTP limit is reached, all outputs, except standby, will shutdown and remain off until the over temperature condition no longer exists.

Ambient thermal sensor accuracy is within +/- 3°C.

Model Number	Parameter (Inlet Air Temperature)	Output	Min	Max	Unit
CSU2000ADC-3-100	Over Temperature Warning (OTW)	100% Load	61	/	°C
	Over Temperature Shutdown (OTP)	100% Load	65	/	°C
	Over Temperature Warning (OTW)	60% Load	68	/	°C
	Over Temperature Shutdown (OTP)	60% Load	72	/	°C
CSU2000ADC-3-101	Over Temperature Warning (OTW)	100% Load	51	/	°C
	Over Temperature Shutdown (OTP)	100% Load	57	/	°C
	Over Temperature Warning (OTW)	60% Load	58	/	°C
	Over Temperature Shutdown (OTP)	60% Load	64	/	°C

ELECTRICAL SPECIFICATIONS

Over Current Protection (OCP)

CSU2000ADC series includes internal current limit circuitry to prevent damage in the event of overload or short circuit. It has over current protection (OCP), over current warning (OCW), and over power protection (OPP) limits as defined in table below. They are defined to protect the PSU and to allow peak current to power the system without the PSU shutting down. Fast OCW and slow OCW levels are defined to assert SMBAlert to allow the system to throttle power to protect the PSU and also to allow peak current draws by the system. When OCP trips, it will shutdown and latch off the PSU. The latched PSU is cleared by an DC power cycle or PSON recycle. The power supply can not be damaged from repeated power cycling in this condition. $12V_{SB}$ is auto-recovered after removing OCP limit.

Parameter	Thresholds		Timing		Protection Mode ¹
	Min	Max	Min	Max	
V_O Output Fast Overcurrent Warning ¹	207A	261A	5 μ S	20 μ S	SMBAlert
V_O Output Fast Overcurrent Protection ²	261A	267A	0.1mS	-	Foldback then latch after min timing
V_O Output Slow Overcurrent Warning ³	189A	201A	10mS	15mS	SMBAlert
V_O Output Slow Overcurrent Protection1	201A	207A	20mS	0.1S	Shut down and latch only after min - max timing
V_O Output Slow Overcurrent Protection2 ⁴	180A	189A	20S	-	SMBAlert
V_{SB} Output Overcurrent Protection	4.2A	5.0A	10mS	-	Shut down and hiccup mode

- Note 1 - Fast OCW threshold must be set below the OPP / Fast OCP threshold. Fast OCW shall hold the SMBAlert# signal asserted for 50msec to 150msec; then is allowed to de-assert.
- Note 2 - Over power protection mode shall be held for at least 100 μ sec before OCP shuts down the PSU.
- Note 3 - Slow OCW threshold must be set below the Slow OCP threshold.
- Note 4 - OCP threshold Nom can be set at 188A. Length of time when the 20sec peak power can be supported is based on the thermal transient response of the power supply and the assertion of the SMB_ALERT# signal. The SMB_ALERT# signal should not assert for a minimum of 20 secs during the peak power event at maximum ambient temperature.

ELECTRICAL SPECIFICATIONS

Thermal Warning, CLST, SLOW OCW, SLOW OCP

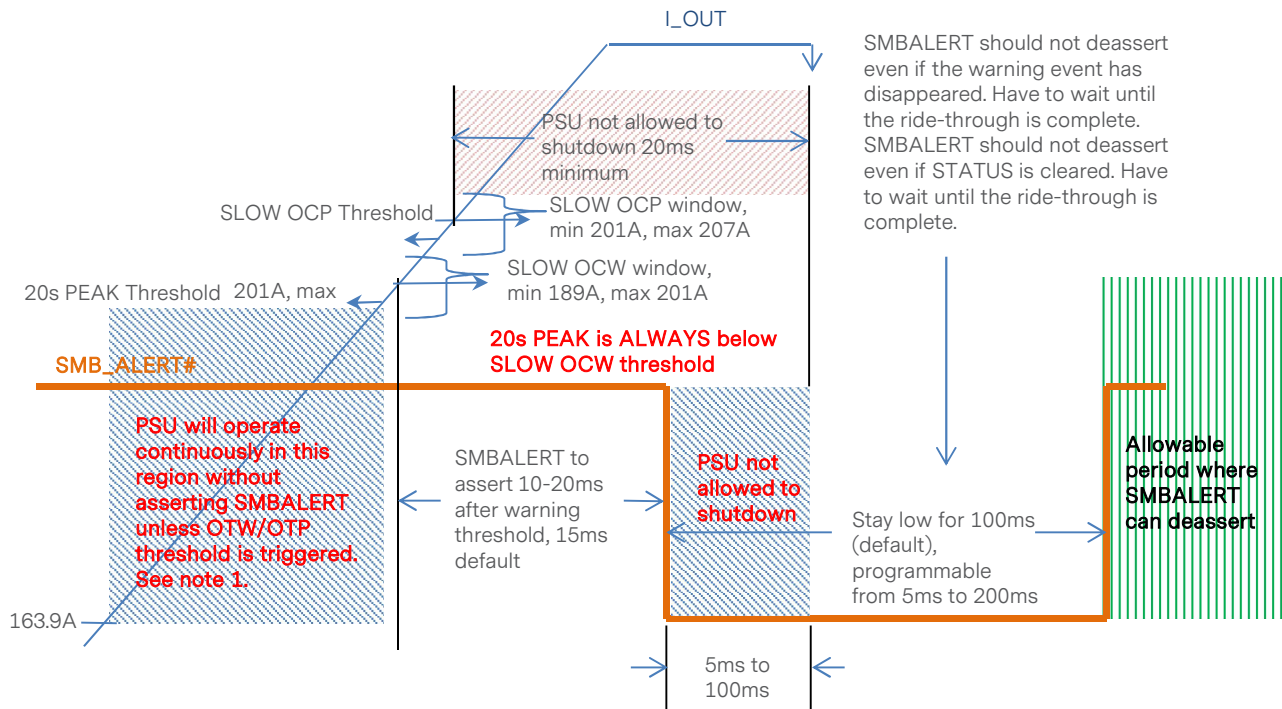

Note 1 - OTW threshold should be set, at the minimum, 4°C below the OTP threshold. OTW asserts SMBALERT, sets STATUS, but does not shutdown the PSU. PSU will shutdown when OTP threshold is triggered.

Note 2 - The system must ensure that the average of the pulsed currents do not exceed the DC-max rating of the power supply.

ELECTRICAL SPECIFICATIONS

Fast OCW, Fast OCP

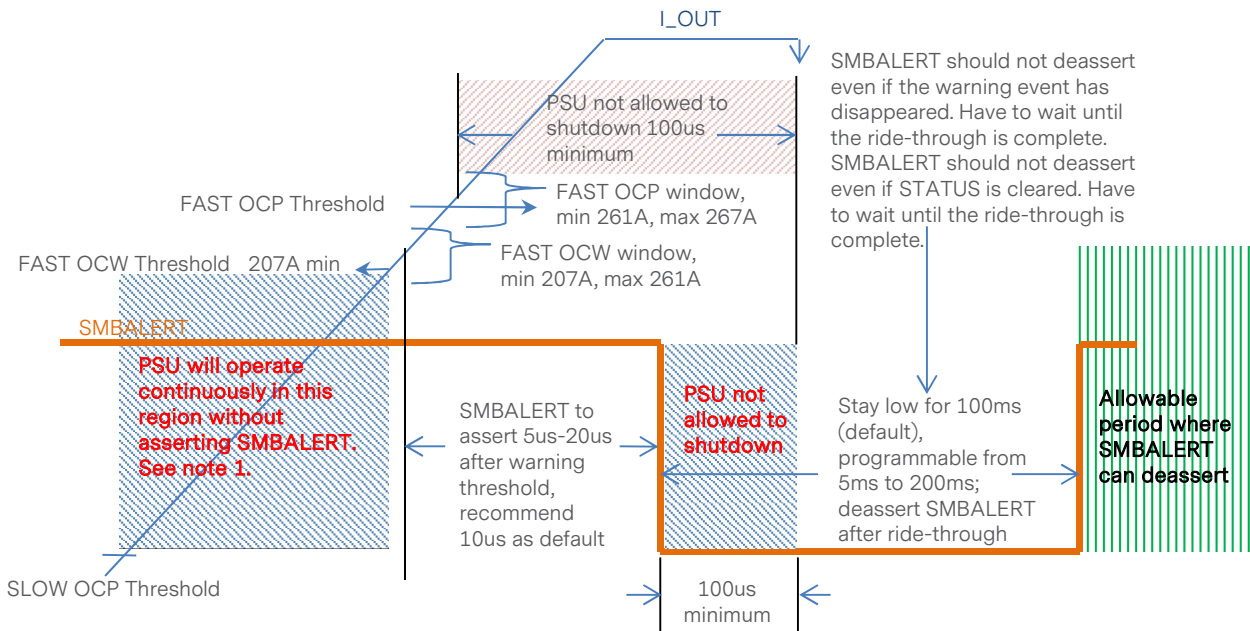

Note 1 - The system must ensure that the average of the pulsed currents do not exceed the DC-max rating of the power supply.

MECHANICAL SPECIFICATIONS

Mechanical Outlines CSU2000ADC-3-100 (unit: mm)

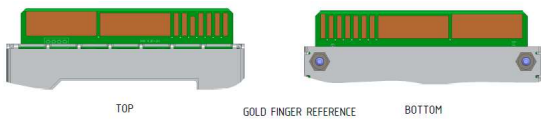
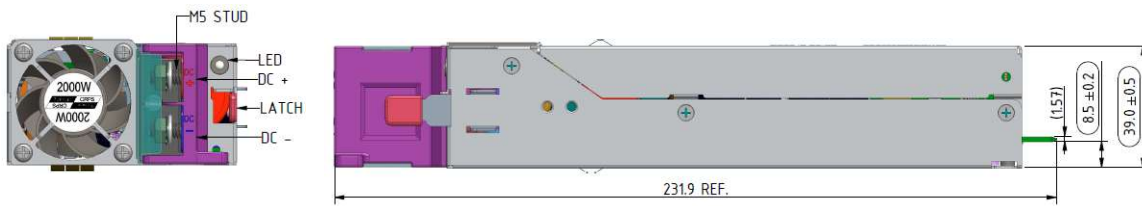
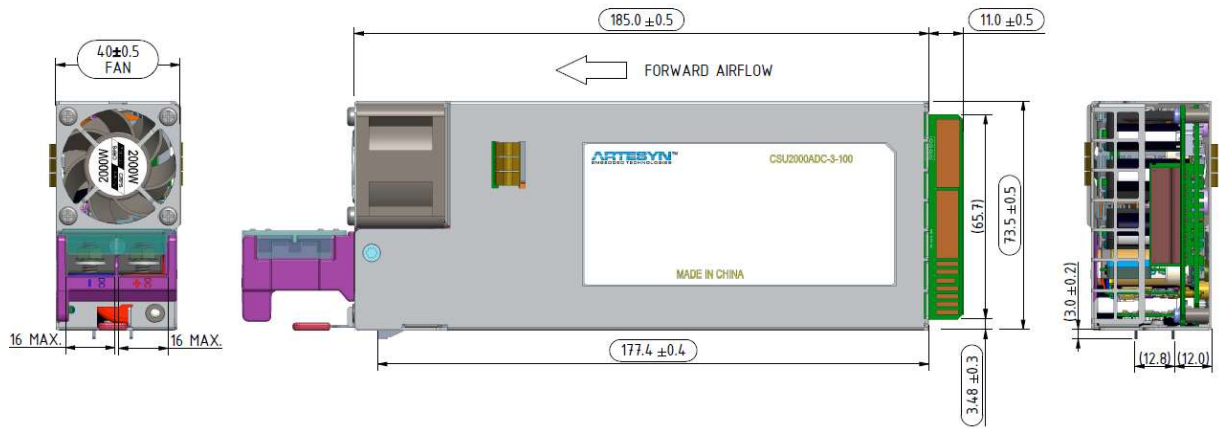

MECHANICAL SPECIFICATIONS

Connector Definitions

DC Input Connector

Pin 1	-	DC+
Pin 2	-	DC-

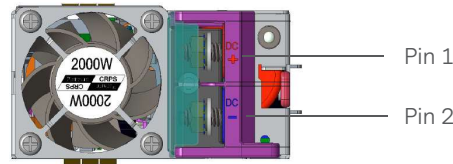

Output Connector - Power Blades

A1-A9	-	Main Output Return
A10-A18	-	Main Output (V _O)
B1-B9	-	Main Output Return
B10-B18	-	Main Output (V _O)

Output Connector - Control Signals

A19	-	SDA
A20	-	SCL
A21	-	PSON
A22	-	SMBAlert
A23	-	Return Sense
A24	-	+12V remote sense
A25	-	PWOK
B19	-	A0 (SMBus Address)
B20	-	A1 (SMBus Address)
B21	-	12V _{SB}
B22	-	Cold Redundancy BUS
B23	-	12V Load Share Bus
B24	-	GND
B25	-	VIN_GOOD

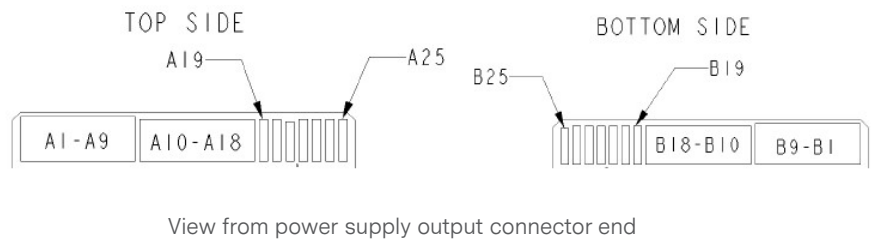

MECHANICAL SPECIFICATIONS

Power / Signal Mating Connectors and Pin Types

Table 5. Mating Connectors for CSU2000ADC Series		
Reference	On Power Supply	Mating Connector or Equivalent
DC Input Connector	Terminal blocks, 1 lug for 800W, 2 lugs for 1300W and greater M5 X 0.85mm hex nut	NA
Output Connector	Card-edge	2x25 pin configuration of the FCI power card connector 10147875-001LF or any approved equivalent

Acoustic Performance

Table 6. Acoustic				
Power Supply Inlet Temperature Condition	% of Maximum Loading Condition	Altitude	Optional Declared Sound Power (BA)	Required Sound Pressure (dBA)
50°C	80%	900m	7.4	79
45°C	45%	900m	4.7	68
35°C	20%	900m	3.8	60

MECHANICAL SPECIFICATIONS

LED Indicator Definitions

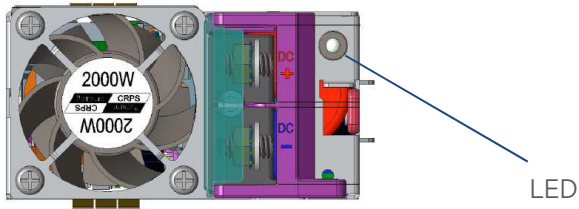

One bi-color (green/amber) LED at the power supply front provides the status signal. The status LED conditions are shown on the following table.

Conditions	LED Status
Output ON and OK.	Green
No DC input power to all power supplies.	Off
PSU standby state DC present / Only 12V _{SB} on (PS off) / Cold standby state or always standby state as defined in the Cold Redundancy section.	1Hz Blink Green
DC cord unplugged with a second power supply in parallel still with DC input power.	Amber
Power supply critical event causing a shutdown. (Failure, over current, short circuit, over voltage, fan failure, over temperature)	Amber
Power supply warning events where the power supply continues to operate. (High temp, high power, high current, slow fan)	1Hz Blink Amber
Power supply firmware updating.	2Hz Blink Green
Compatibility fault (function disabled if compatibility pin is disabled).	Amber

MECHANICAL SPECIFICATIONS

Weight

The CSU2000ADC-3 series power supply weight is 1050g/2.315lbs.

ENVIRONMENTAL SPECIFICATIONS

EMC Immunity

CSU2000ADC series power supply is designed to meet the following EMC immunity specifications.

Table 7. Environmental Specifications	
Document	Description
Class A of EN55032 and FCC CFR 47 Part 15 Subpart B	Conducted and Radiated EMI Limits
IEC/EN61000-4-2	Electromagnetic Compatibility (EMC) - Testing and measurement techniques - Electrostatic discharge immunity test: 15kV air, 8kV contact discharge. Performance - Criteria A
IEC/EN61000-4-3	Electromagnetic Compatibility (EMC) - Testing and measurement techniques - Radiated, radio-frequency, electromagnetic field immunity test: 10V/m. Performance - Criteria A
IEC/EN61000-4-4	Electromagnetic Compatibility (EMC) - Testing and measurement techniques - Electrical fast transient/burst immunity test: +/-2kV for DC ports. Performance - Criteria A
IEC/EN61000-4-5 GR1089	Electromagnetic Compatibility (EMC) - Testing and measurement techniques - Surge test: +/-1.5KV common mode and +/-1.5KV differential mode for DC ports. Performance - Criteria A
IEC/EN61000-4-6	Electromagnetic Compatibility (EMC) - Testing and measurement techniques - Conducted Immunity 10Vrms. Performance - Criteria A.
IEC61000-4-12	Ring wave, 2KV common mode and 1KV differential mode. Performance - Criteria A.

Notes: Performance Criteria as defined by EN300386.

Performance Criteria A: The apparatus shall continue to operate as intended after the test. No degradation of performance or loss of function is allowed below specified performance level during intended use of operation.

Performance Criteria B: The apparatus shall continue to operate as intended after the test. No degradation of performance or loss of function is allowed below specified performance level during intended use of operation. Degradation of performance is allowed during the exposure to an electromagnetic phenomenon but no change of actual operating state is allowed.

Performance Criteria C: Temporary loss of function is allowed, provided the function is self-recoverable or can be restored by the operation of the controls.

ENVIRONMENTAL SPECIFICATIONS

Safety Certifications

The CSU2000ADC series power supply is intended for inclusion in other equipment and the installer must ensure that it is in compliance with all the requirements of the end application. This product is only for inclusion by professional installers within other equipment and must not be operated as a stand alone product.

Table 8. Safety Certifications for CSU2000ADC Series Power Supply		
Standard	Agency	Description
UL 62368-1:2014, CAN/CSA C22.2 No.62368-1-14	UL + CUL	US and Canada Requirements
EN 62368-1:2014	CE	European Requirements
IEC60950-1:2005	UL + CB	International Requirements
CB Certificate and Report		All CENELEC Countries
CHINA CCC or CQC Approval		China Requirements
KC		Korea Certification
BIS		India Requirements
CE Mark		European Requirements
UKCA Mark		UK Requirements

ENVIRONMENTAL SPECIFICATIONS

EMI Emissions

The CSU2000ADC series power supply has been designed to comply with the Class A limits of EMI requirements of FCC CFR 47 Part 15 Subpart B and EN55032 for emissions and relevant sections of EN55032: 2011 for immunity. The unit is tested at 2000W using resistive load with cooling fan.

Conducted Emissions

The applicable standard for conducted emissions is EN55032 (FCC Part 15). Conducted noise can appear as both differential mode and common mode noise currents. Differential mode noise is measured between the two input lines, with the major components occurring at the supply fundamental switching frequency and its harmonics. Common mode noise, a contributor to both radiated emissions and input conducted emissions, is measured between the input lines and system ground and can be broadband in nature.

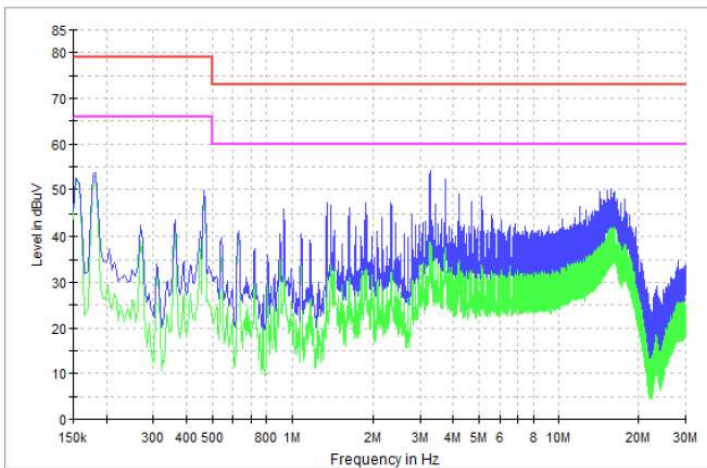

The CSU2000ADC series power supply has EMI filters to ensure the convertor’s conducted EMI levels comply with EN55032 (FCC Part 15) Class A limits. The EMI measurements are performed with resistive loads at maximum rated loading.

Sample of EN55032 conducted EMI measurement at -48Vdc input.

Note: Red Line refers to Artesyn Quasi Peak margin, which is 6dB below the CISPR international limit. Pink Line refers to the Artesyn Average margin, which is 6dB below the CISPR international limit.

Conducted EMI emissions specifications of the CSU2000ADC series power supply:

Parameter	Model	Symbol	Min	Typ	Max	Unit
FCC Part 15, class A	All	Margin	-	6	-	dB
CISPR 32 (EN55032), class A	All	Margin	-	6	-	dB

ENVIRONMENTAL SPECIFICATIONS

Radiated Emissions

Unlike conducted EMI, radiated EMI performance in a system environment may differ drastically from that in a stand-alone power supply. The shielding effect provided by the system enclosure may bring the EMI level from Class A to Class B. It is thus recommended that radiated EMI be evaluated in a system environment. The applicable standard is EN55032 Class A (FCC Part 15). Testing DC-DC converters as a stand-alone component to the exact requirements of EN55032 can be difficult because the standard calls for 1m lead to be attached to the input and outputs and aligned such as to maximize the disturbance. In such a set-up, it is possible to form a perfect dipole antenna that very few DC-DC converters could pass. However, the standard also states that an attempt will be made to maximize the disturbance consistent with the typical application by varying the configuration of the test sample.

ENVIRONMENTAL SPECIFICATIONS

Operating Temperature

The CSU2000ADC-3-100 power supply starts and operates with full rated power at an ambient temperature from -5°C to 55°C. Allowable up to 65°C at 60% load.

Table 9. Operating Temperature Requirements (Air Inlet Temperature)				
Model	Output Power	Altitude	Operating Temperature	
			Min	Max
CSU2000ADC-3-100	2000W	900m	-5°C	55°C ²
	2000W	5000m	-5°C	40°C ¹
	1200W	Sea level	-5°C	65°C ¹
CSU2000ADC-3-101	2000W	900m	-5°C	45°C
	2000W	5000m	-5°C	35°C ¹
	1200W	Sea level	-5°C	55°C ¹

Note 1 - Safe operating point where components are within thermal rating.
 Note 2 - Specified operating condition.

Thermal Derating Curve

Forward Airflow: Output power derated linearly from 100% to 60% when operating from 55°C to 65°C.
 Reverse Airflow: Output power derated linearly from 100% to 60% when operating from 40°C to 50°C.

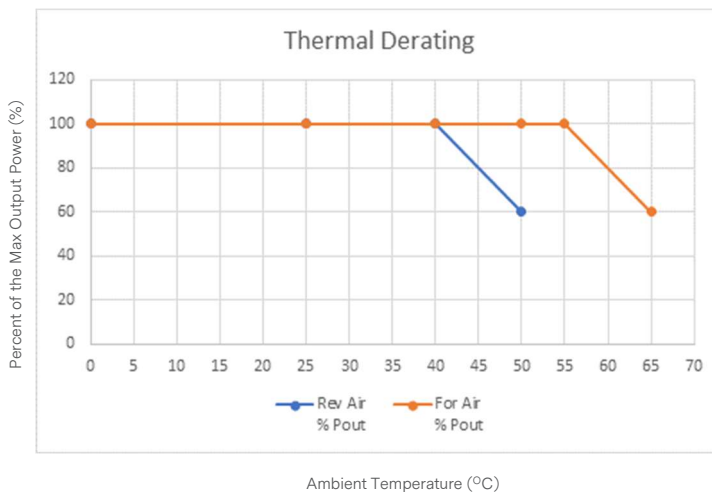

Note 1 - Forward air: Ambient temperature derating of 1°C for every 270m above 950m.
 Note 2 - Reverse air: Ambient temperature derating of 1°C for every 410m above 950m.

ENVIRONMENTAL SPECIFICATIONS

Forced Air Cooling

The CSU2000ADC series includes internal cooling fans as part of the power supply assembly to provide forced air-cooling to maintain and control temperature of devices and ambient temperature in the power supply to appropriate levels. The standard direction of airflow is from the DC output connector end to the Input connector end of the power supply. The power supply must meet thermal requirements at according to Table 3 and Table 9.

Fan PQ Curve

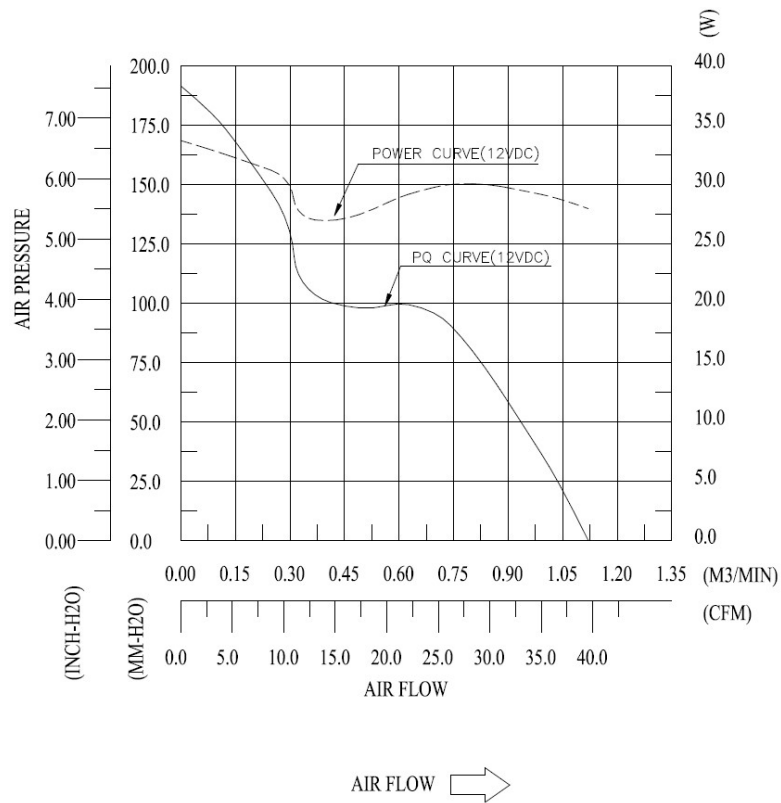

PWM Duty Cycle vs. RPM (T_A=25°C)

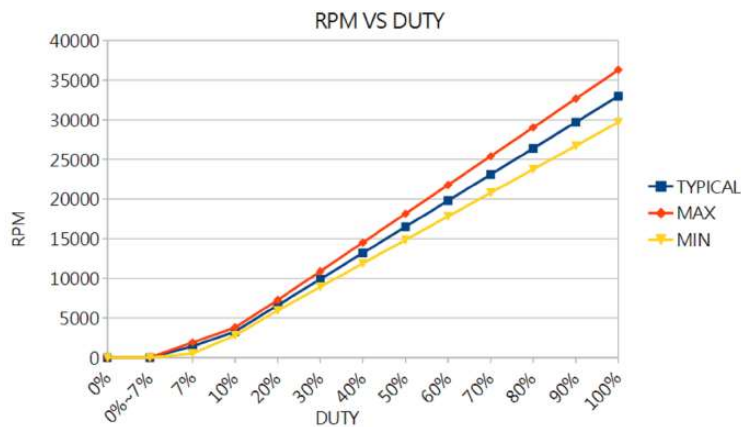

ENVIRONMENTAL SPECIFICATIONS

Storage and Shipping Temperature

The CSU2000ADC series power supply can be stored or shipped at temperatures between -40°C to +70°C and relative humidity from 5% to 95% non-condensing.

Altitude

The CSU2000ADC series power supply is certified for safety spacing's requires for 5000 meters altitude. The power supply will not be damaged when stored at altitudes of up to 15200 meters above sea level.

Humidity

The CSU2000ADC series power supply can operate within specifications when subjected to a relative humidity from 5% to 95% non-condensing. The power supply can be stored in a relative humidity from 5% to 95% non-condensing.

Vibration

The CSU2000ADC series power supply will pass the following vibration specifications:

Non-Operating Random Vibration

Acceleration	3.13		gRMS
Frequency Range	5 - 500		Hz
Duration	15		Mins
Direction	3 mutually perpendicular axis		
PSD Profile	FREQ (Hz)	SLOPE (db/oct)	PSD (g ² /Hz)
	5	/	0.01
	20	/	0.02
	20 - 500	/	0.02

Operating Random Vibration

Acceleration	1.5		gRMS
Frequency Range	5 - 500		Hz
Duration	30		Mins
Direction	3 mutually perpendicular axis		
PSD Profile	FREQ (Hz)	SLOPE (db/oct)	PSD (g ² /Hz)
	5 - 50	/	0.002
	50 - 100	/	0.04

ENVIRONMENTAL SPECIFICATIONS

Shock

The CSU2000ADC series power supply will pass the following vibration specifications:

Non-Operating Half-Sine Shock

Acceleration	50	G
Duration	170	in. / sec
Pulse	Trapezoidal wave	
Number of Shock	3 shocks in each of 6 faces	

Operating Half-Sine Shock

Acceleration	20	G
Duration	10	mSec
Pulse	Half-Sine	
Number of Shock	3 shocks in each of 6 faces	

Thermal Shock

Non-operating	-40°C to 70°C
Transition times	Between 15°C/min to 30°C/min, 30 min dwell on temperature extremes for each half cycle
Number of Shock	50 cycles

POWER AND CONTROL SIGNAL DESCRIPTIONS

DC Input Connector

This connector supplies the DC Mains to the CSU2000ADC series power supply.

- Pin 1 - DC+
- Pin 2 - DC-

Output Connector - Power Blades

These pins provide the main output for the CSU2000ADC series power supply. The Main Output (V_O) and the Main Output Return pins are the positive and negative rails, respectively, of the V_O main output of the CSU2000ADC series power supply. The Main Output (V_O) is electrically isolated from the power supply chassis.

- A1-A9 - Main Output Return
- A10-A18 - Main Output (V_O)
- B1-B9 - Main Output Return
- B10-B18 - Main Output (V_O)

Output Connector - Control Signals

The CSU2000ADC series power supply contains a 14 pins control signal header providing an analogue control interface, standby power and I²C interface signal connections.

SDA, SCL, A0, A1 - (Pins A19, A20, B19, B20)

Please refer to “Communication Bus Descriptions” section on page 35.

PSON - (Pin A21)

This signal input pin controls the normal turn on and off of the main output of the CSU2000ADC series power supply. The power supply main output (V_O) will be enabled when this signal is pulled low below 0.8V. The power supply output (except V_{SB} output) will be disabled when this input is driven higher than 2.0V. This signal can be pulled high to 5V maximum. The PSU has a 10K ohm internal pull-up resistor, hence no additional pull-up resistor required by system. The source current is 4mA maximum when V_{psn} is low.

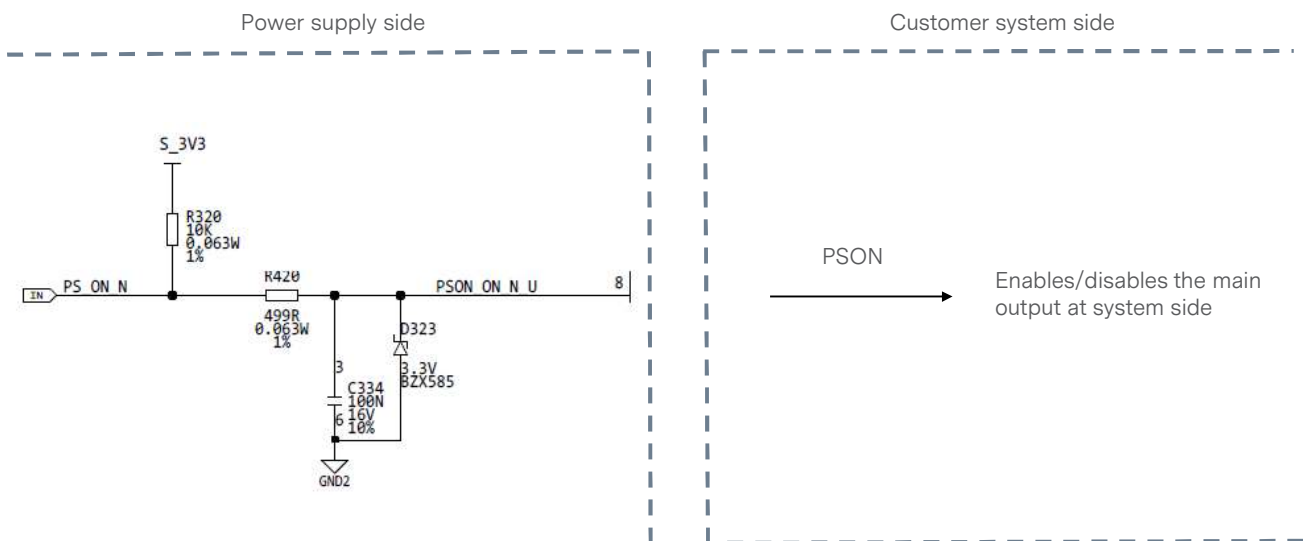

POWER AND CONTROL SIGNAL DESCRIPTIONS

SMBALERT - (Pin A22)

SMBALERT is an active low signal used to send an interrupt to the system that a warning or critical event in the PSU occurred. The pin is normally high. It is asserted (goes low) when a warning or fault occurred. The conditions where in the signal is de-asserted (goes back to high) are DC input recycle, PSON recycle and issuance of a CLEAR_FAULTS PMBus™ command. The power supply will assert the SMBALERT < 4ms after DC input voltage is lost to 0V.

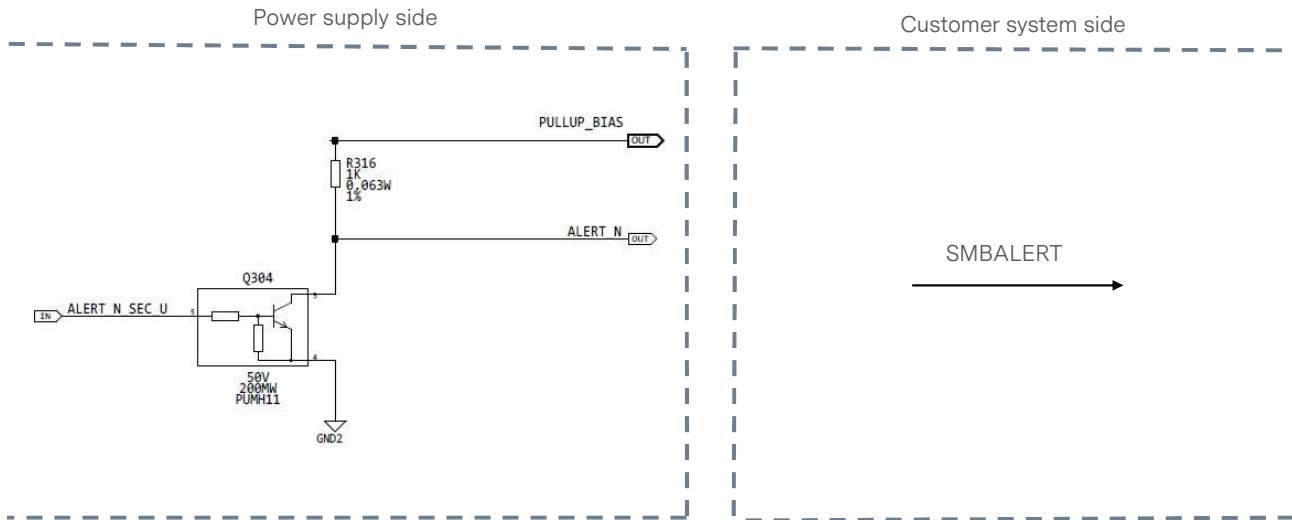

+VSENSE & -VSENSE - (Pins A23, A24)

This remote sense circuit will be designed to compensate for a power path drop around the entire loop of 0.1V. These pins should be connected as close to the loading as possible. If left open, the remote sense will not work properly and the voltage level of main output will go lower than the guaranteed spec.

PWOK - (Pin A25)

The PWOK is an output signal driven high above 2.0V by the power supply to indicate that all outputs are valid. If any of the power supply outputs fails below its regulation limits, this signal will be driven low below 0.4V. The sink current is 0.4mA maximum when the signal is low and is 2mA maximum when the signal is high. The rise time and fall time of the signal is 100uS maximum. If the DC input power is lost, this signal must be driven low at least 20ms before the standby output goes below regulation range. This signal has 1K ohm pull-up resistor connected to standby bus before oring device inside PSU.

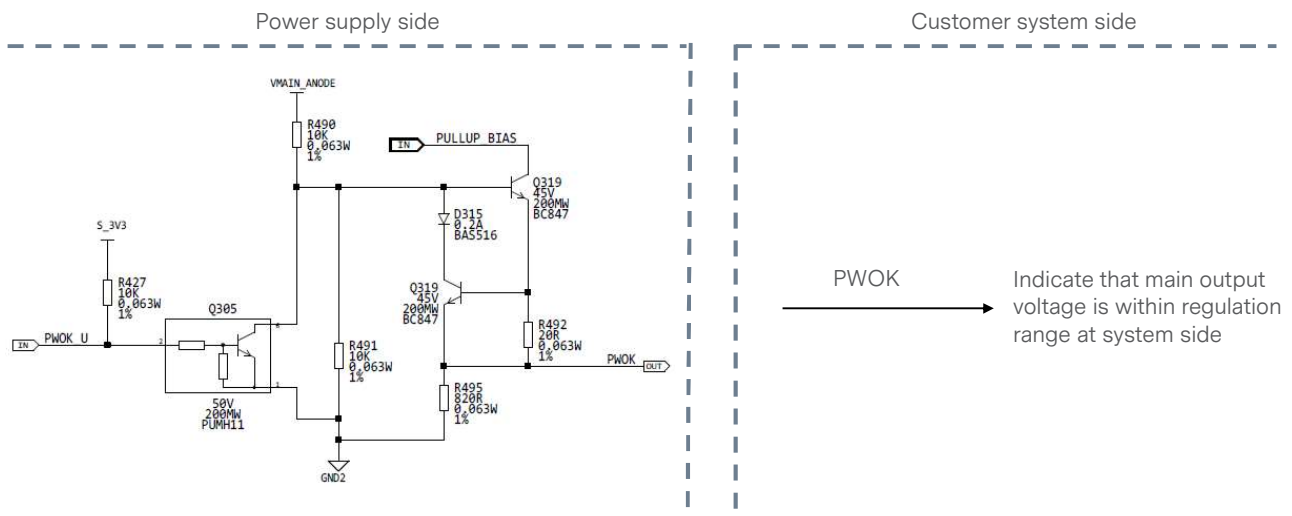

POWER AND CONTROL SIGNAL DESCRIPTIONS

CR_BUS - (Pin B22)

There is an additional signal defined supporting cold redundancy. This is connected to a bus shared between the power supplies and CR_BUS. This is a tri-state output signal of the power supply used to communicate a fault or Vout under-voltage level has occurred in one of the power supplies. This is used to power on all the power supplies in the system via the CR_BUS. When the signal is pulled high, it allows all power supplies in cold standby mode to go into cold standby state when the load share voltage is below the VCR_ON level. When the signal is left open on all power supplies, it forces all cold standby power supplies into the ON. The cold redundancy section showing the logic state of the CR_BUS signal depending upon the programmed configuration of the power supply in D0h, the operating state of the power supply, and the power supply fault status.

Refer cold redundancy part for details.

12V Load Share - (Pin B23)

12V load share is a single wire bus signal used to help equalize the output current from two or more power supplies connected to a common load. The current share signal is a DC signal that represents the load current that a power supply is providing. This voltage increases proportionately with the output load. The expected voltage levels are stated as below table.

ISHARE signal voltage of the CSU2000ADC series power supply:

Load (per power supply unit)	Model	Min	Nom	Max	Unit
100% $I_{O,max}$	All	-	8.0	-	Vdc
50% $I_{O,max}$	All	-	4.0	-	Vdc
10% $I_{O,max}$	All	-	0.8	-	Vdc

GND (Used by system for presence detect) - (Pin B24)

This signal used to indicate to the system that a power supply is inserted in the power bay. This pin is grounded inside the power supply. Recommended pull-up resistor to 12Vsb is 8.2k ohm with a 3.0k ohm pull-down to ground. A 100pF decoupling capacitor is also recommended.

- Low - PS is present.
- High - PS is removed from system.

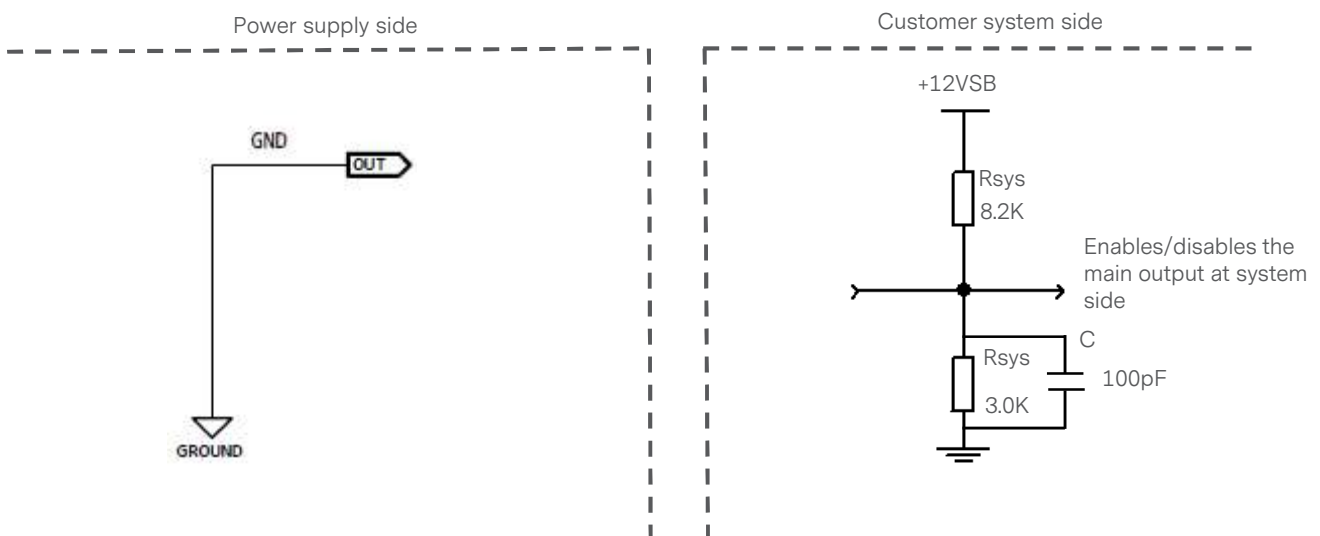

POWER AND CONTROL SIGNAL DESCRIPTIONS

VIN_GOOD - (Pin B25)

When B25 is used as VIN_GOOD, this signal will be asserted, driven HIGH (>2.0V) by the power supply to indicate that the input applied is within the valid range. If the input power is lost to 0V, this signal must be driven low. The sink current is 0.4mA maximum when the signal is low and is 2mA maximum when the signal is high. The rise time and fall time of the signal is 100µS maximum.

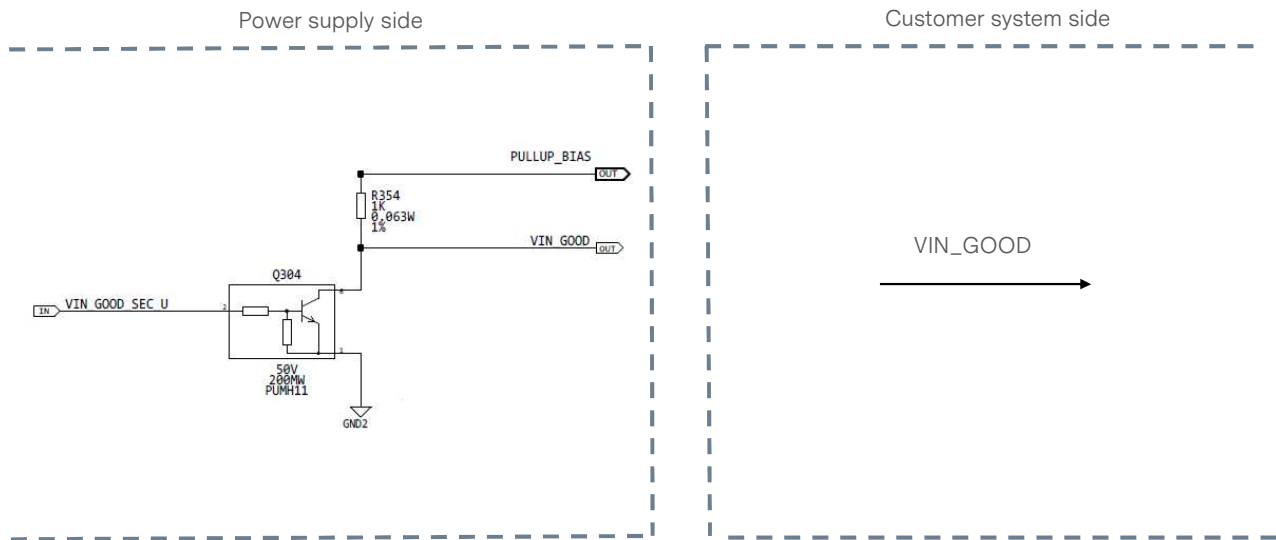

COMMUNICATION BUS DESCRIPTIONS

I²C Bus Signals

CSU2000ADC series power supply contains enhanced monitor and control functions implemented via the I²C bus. The CSU2000ADC series I²C functionality (PMBus™ and FRU data) can be accessed via the output connector control signals. The communication bus is powered either by the internal 3.3V supply or from an external power source connected to the standby output (i.e. accessing an unpowered power supply as long as the standby output of another power supply connected in parallel is on).

If units are connected in parallel or in redundant mode, the standby outputs must be connected together in the system. Otherwise, the I²C bus will not work properly when a unit is inserted into the system without the DC source connected.

Note: PMBus™ functionality can be accessed only when the PSU is powered-up. Guaranteed communication I²C speed is 100KHz.

A0, A1 (I²C Address Signals) - (Pins B19, B20)

These input pins are the address lines A0 and A1 to indicate the slot position the power supply occupies in the power bay and define the power supply addresses for FRU data and PMBus™ data communication. This allows the system to assign different addresses for each power supply. During I²C communication between the system and power supplies, the system will be the master and the power supplies will be the slave. They are internally pulled up to internal 3.3V supply.

SDA, SCL (I²C Data and Clock Signals) - (Pins A19, A20)

I²C serial data and clock bus - these pins must be pulled-up by a 2.2K ohm resistor to 3.3V at the system side.

I²C Bus Communication Interval

The interval between two consecutive I²C communications to the power supply must be at least 15ms to ensure proper monitoring functionality.

I²C Bus Signal Integrity

The noise on the I²C bus (SDA, SCL lines) due to the power supply will be less than 300mV peak-to-peak. This noise measurement should be made with an oscilloscope bandwidth limited to 100MHz. Measurements must be made at the power supply output connector with 10Kohm resistors pulled up to 3.3V source and a decoupling 47pF ceramic capacitors to standby output return.

COMMUNICATION BUS DESCRIPTIONS

I²C Bus Internal Implementation, Pull-ups and Bus Capacitances

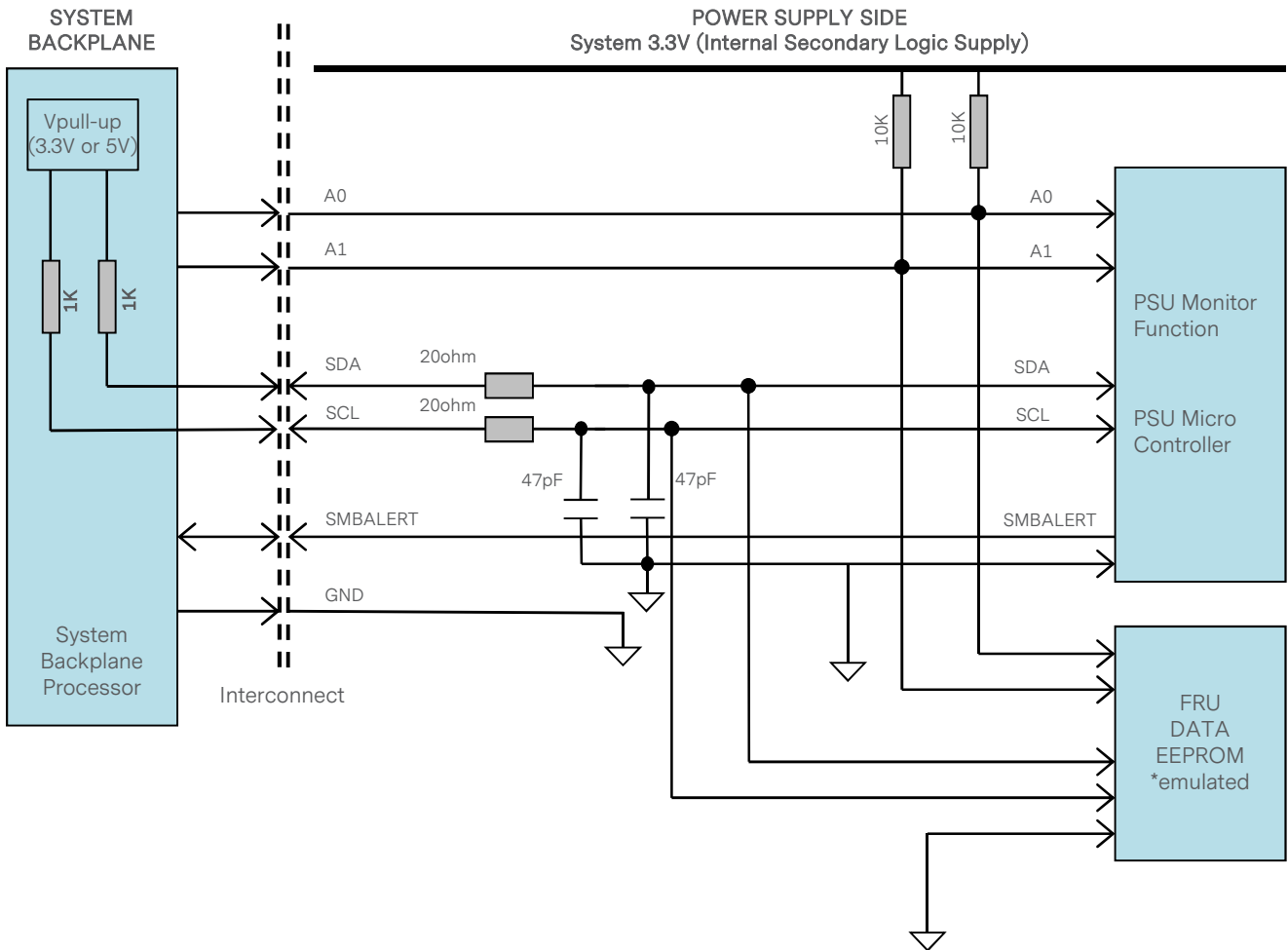

I²C Bus - Recommended external pull-ups

Electrical and interface specifications of I²C signals (referenced to standby output return pin, unless otherwise indicated):

Parameter	Condition	Symbol	Min	Type	Max	Unit
SDA, SCL Internal Pull-up Resistor		R_{int}	-	-	-	Kohm
SDA, SCL Internal Bus Capacitance		C_{int}	-	47	-	pF
Recommended External Pull-up Resistor	1 to 4 PSU	R_{ext}	-	1	-	Kohm
Recommended External Pull-up Voltage		$V_{pull-up}$	3.3	-	5	V

COMMUNICATION BUS DESCRIPTIONS

Logic Levels

CSU2000ADC series power supply I²C communication bus will respond to logic levels as per below:

Logic High: 3.3V nominal (Spec is 2.1V to 5.5V)**

Logic Low: 500mV nominal (Spec is 800mV max)**

**Note: Artesyn 73-769-001 I²C adapter was used.

Timings

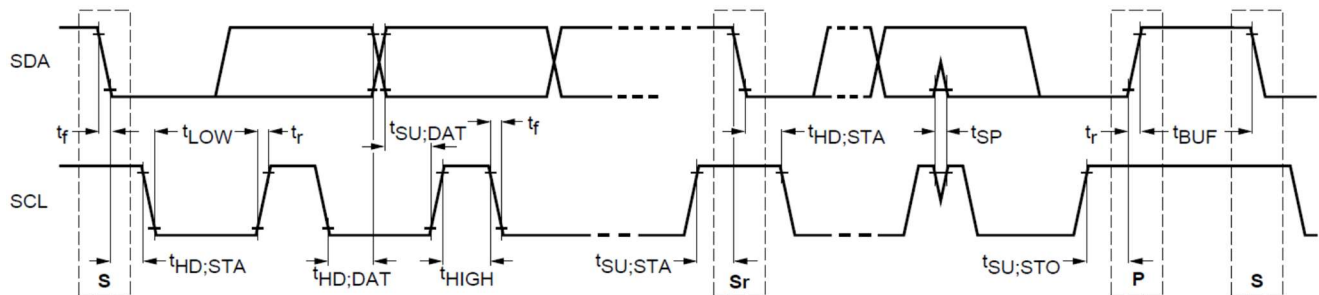

Parameter	Symbol	Standard-Mode Specs		Actual Measured		Unit
		Min	Max			
SCL clock frequency	f_{SCL}	10	100	100		KHz
Hold time (repeated) START condition	$t_{HD;STA}$	4.0	-	4.8		uS
LOW period of SCL clock	t_{LOW}	4.7	-	5.3		uS
HIGH period of SCL clock	t_{HIGH}	4.0	-	4.2		uS
Setup time for repeated START condition	$t_{SU;STA}$	4.7	-	5.4		uS
Data hold time	$t_{HD;DAT}$	0	3.65	0.4		uS
Data setup time	$t_{SU;DAT}$	250	-	4200		nS
Rise time	t_r	-	1000	SCL = 320	SDA = 480	nS
Fall time	t_f	-	300	SCL = 160	SDA = 155	nS
Setup time for STOP condition	$t_{SU;STO}$	4.0	-	5.56		uS
Bus free time between a STOP and START condition	t_{BUF}	4.7	-	880***		uS

***Note: Artesyn 73-769-001 I²C adapter (USB-to-I2C) and Universal PMBus™ GUI software was used.

COMMUNICATION BUS DESCRIPTIONS

Device Addressing

The CSU2000ADC series power supply will respond to supported commands on the I²C bus that are addressed according to A1 and A0 pins of output connector.

Address pins are held HIGH by default via pulled up to internal 3.3V supply. To set the address as “0”, the corresponding address line needs be pulled down to logic ground level. Below tables show the address of the power supply with A0 and A1 pins set to either “0” or “1”.

PSU Slot	Slot ID Bits		PMBus™ Address	EEPROM (FRU) Address
	A1	A0		
1	0	0	0xB0	0xA0
2	0	1	0xB2	0xA2
3	1	0	0xB4	0xA4
4	1	1	0xB6	0xA6

COMMUNICATION BUS DESCRIPTIONS

I²C Clock Synchronization

The CSU2000ADC-3 series power supply applies clock stretching. An addressed slave power supply holds the clock line (SCL) low after receiving (or sending) a byte, indicating that it is not yet ready to process more data. The system master that is communicating with the power supply will attempt to raise the clock to transfer the next bit but must verify that the clock line was actually raised. If the power supply is clock stretching, the clock line will still be low (because the connections are open-drain).

The maximum time-out condition for clock stretching for CSU2000ADC series is 30 milliseconds.

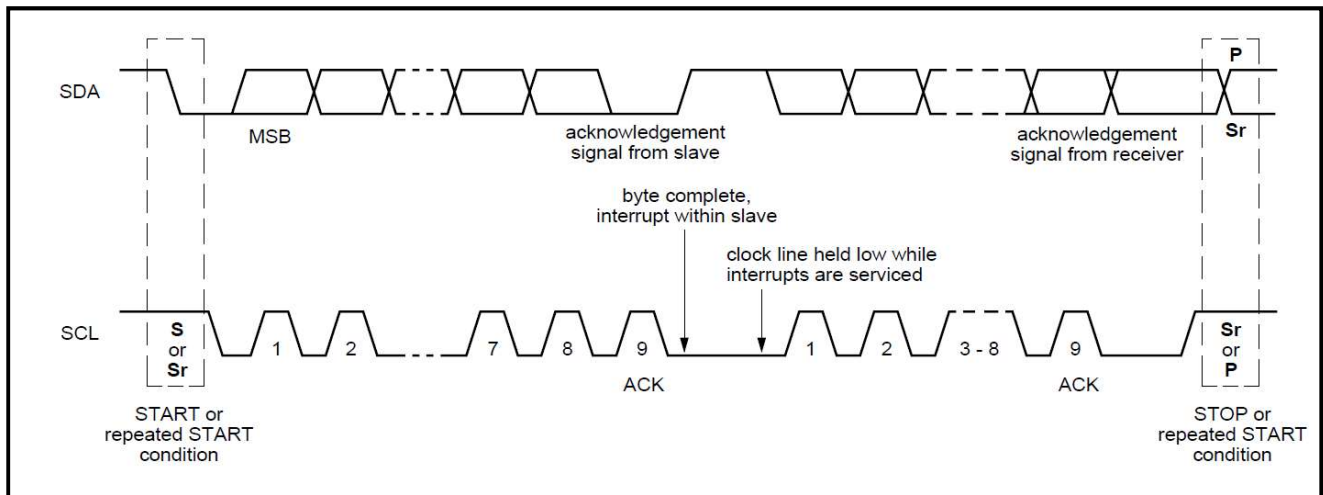

COMMUNICATION BUS DESCRIPTIONS

Cold Redundancy

The CSU2000ADC series power supply supports capabilities for cold redundancy. This capability helps improve the efficiency and iTHD of the power subsystem when more than one power supply is used in a system. Cold redundancy uses the PMBus™ manufacturer specific command area to define commands for the system to configure the power supplies for cold redundancy.

Overview

A system in 1+1, 2+1, 3+1 or 2+2 redundant mode configuration may not be operated at the optimum efficiency especially when the load is <50% of each power supply's capacity. The cold redundancy mode addresses this condition, where certain power supplies in a system can go into "cold standby" mode, thereby consuming the least amount of power and still be redundant.

Each power supply in this system will have a preprogrammed threshold for output current by which that power supply may determine whether to be actively providing power to the system, or be in cold standby state. A CR_BUS signal that connects all power supplies in the system, also indicates whether it is safe for power supplies in cold redundant mode to enter into cold standby state. The CR_BUS signal prevents power supplies from going into cold standby mode whenever there isn't any active power supply.

The following table shows the state of the power supplies programmed for cold standby mode based on the condition of the CR_BUS signal and the load share bus voltage.

Logic Matrix for Cold Standby Power Supplies:

CR_BUS	Load Share	Cold Standby Power Supply State(s)
High	< VCR_ON	Cold Standby
Low	< VCR_ON	Active
High	> VCR_ON	Active
Low	> VCR_ON	Active

Note: VCR_ON is the voltage threshold set inside the power supplies configured for cold standby which tells them to power down into cold standby state when the load share voltage is less than VCR_ON.

When CR_BUS is asserted (or goes low), all power supplies in the system should go active and immediately provide power to the system.

SMBus Commands for Cold Redundancy

Configuring Cold Redundancy with Cold_Redundancy_Config (D0h)

The PMBus™ manufacturer specific command MFR_SPECIFIC_00 is used to configure the operating state of the power supply related to cold redundancy. This command for Cold_Redundancy_Config is D0h. The table below shows the configuration of the power supply based on the value in the Cold_Redundancy_Config register. PEC is used for read/write of this register.

COMMUNICATION BUS DESCRIPTIONS

Cold Redundancy Configuration Table

Cold_Redundancy_Config (D0h)		
Value	State	Description
00h	Standard Redundancy (Default Power on State)	Turns the power supply into standard redundant load sharing mode. The power supply's CR_BUS signal shall be OPEN but still pull the bus low if a fault occurs.
01h	Cold Redundant Active	Defines this power supply to be the one that is always ON in a cold redundancy configuration.
02h	Cold Standby 1	Defines the power supply that is the first to turn on in a cold redundant configuration as the load increases. This power supply usually has the lowest current threshold.
03h	Cold Standby 2	Defines the power supply that is the second to turn on in a cold redundant configuration as the load increases.
04h	Cold Standby 3	Defines the power supply that is the third to turn on in a cold redundant configuration as the load increases.
05h	Always Cold Standby	Defines this power supply to be always in cold redundant configuration no matter what the load condition. Support for this condition will be limited to 1920W maximum output.
06h-FFh	Reserved	

When the CR_BUS transitions from a high to a low state; each PSU programmed to be in cold standby state shall be put into standard redundancy mode (Cold_Redundancy_Config = 00h). For the power supplies to enter cold redundancy mode the system must re-program the power supplies using the Cold_Redundancy_Config command.

Cold Redundant Signal (CR_BUS)

There is an additional signal defined supporting Cold Redundancy. This is connected to a bus shared between the power supplies: CR_BUS. This is a tri-state output signal of the power supply used to communicate a fault or Vout under voltage level has occurred in one of the power supplies. This is used to power on all the power supplies in the system via the CR_BUS. When the signal is pulled high, it allows all power supplies in cold standby mode to go into cold standby state when the load share voltage is below the VCR_ON level. When the signal is left open on all power supplies, it forces all cold standby power supplies into the ON. Below is a table showing the logic state of the CR_BUS signal depending upon the programmed configuration of the power supply in D0h, the operating state of the power supply, and the power supply fault status.

COMMUNICATION BUS DESCRIPTIONS

Cold Redundancy State Table

Cold Redundant Config	Operating State	Power Supply Fault Status	CR_Bus#
Active	On	OK	High
Cold Standby 1,2,3	On	OK	Open
Cold Standby 1,2,3	Cold Standby	OK	Open
Active	Off	Fault	Low
Cold Standby 1,2,3	On	Fault	Low
Cold Standby 1,2,3	Cold Standby	Fault	Low

The CR_Status input is based on both the Cold_Redundancy_Config register as well as the fault state of the power supply. The resulting output is a tri-state output. The output is low when there is a fault in any power supply or when cold redundancy is disabled. The output is high only when a power supply is programmed for the cold redundancy active mode and it is functioning OK. The output is open only when the power supply is programmed for cold redundant standby mode and is functioning OK. This means that there needs to be one good power supply programmed for active cold redundant mode to allow power supply to function in cold standby mode; otherwise, all power supplies will power ON and come out of cold redundant mode.

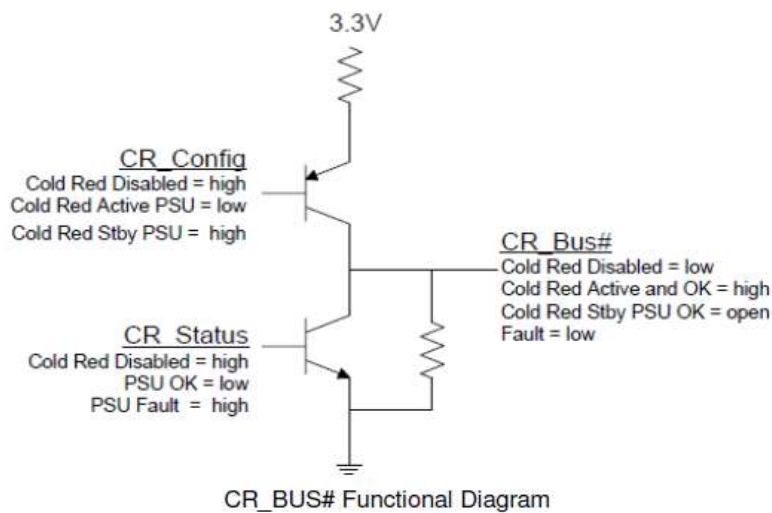

CR_BUS Signal Characteristic

Signal Type	Active: Tri-State Output Cold Standby: Input Signal	
	Min	Max
Logic Level Low (Power Supply ON)	0V	0.4V
Logic Level High (Power Supply OFF)	2.4V	3.46V
Source Current, Cold Amber = High	2mA	-
Sink Current, Cold Amber = Low	400µA	-
Cold Amber Fault Delay	-	10µS
Cold Amber Turn On Delay	-	100µS

COMMUNICATION BUS DESCRIPTIONS

BMC Requirements

The BMC uses the Cold_Redundancy_Config command to configure the power supply's roll in cold redundancy and to enable/disable cold redundancy. It is recommended that the BMC schedules a rolling change for which PSU is the Active, Cold Stby 1, Cold Stby 2, and Cold Stby 3 power supply. This allows for equal loading across power supply over their life.

COMMUNICATION BUS DESCRIPTIONS

Black Box

The power supply can store PMBus and other data into non-volatile memory upon a critical failure that caused the power supply to shut down. The data can be accessed via the PMBus interface by applying power to the 12V_{SB} pins. No DC input power needs to be applied to the power supply.

Data is saved to the black box for the following fault events:

- General fault
- Over voltage on output
- Over current on output
- Loss of input
- Input voltage fault
- Fan failure
- Over temperature

Black Box Process:

- 1) System writes system tracking data to the power supply RAM at power ON.
- 2) System writes the real time clock data to the PSU RAM once every ~5 minutes.
- 3) Power supply tracks the number of PSON and DC power cycles in FLASH.
- 4) Power supply tracks ON time in FLASH.
- 5) Power supply loads warning and fault event counter data from FLASH into RAM.
- 6) Upon a warning event, the PSU will increment the associated counter in RAM.
- 7) Upon and fault event, the PSU will increment the associated counter in RAM.
- 8) Upon a fault event that causes the PSU to shut down, all event data in the PSU's RAM is saved to event data location N in the power supply's FLASH. This data includes the real time clock, the number of DC & PSON power cycles, PSU ON time, warning event counters and fault event counters.

COMMUNICATION BUS DESCRIPTIONS

Commands:

Name: MFR_BLACKBOX

Format: Read Block with PEC (238 bytes)

Code: DCh

	Item	Number of Bytes	Description
System tracking data	System top assembly number	10	The system will write its Intel part number for the system top assembly to the power supply when it is powered ON. This is 9 ASCII characters.
	System serial number	10	The system will write the system serial number to the power supply when it is powered ON. This includes the serial number and date code.
	Motherboard assembly number	10	The system will write the motherboard Intel part number for the assembly to the power supply when it is powered ON. This is 9 ASCII characters.
	Motherboard serial number	10	The system will write the motherboard's serial number to the power supply when it is powered ON. This includes the serial number and date code.
	Present total PSU ON time	3	Total on time of the power supply with PSON asserted in minutes. LSB = 1 minute.
	Present number of DC power cycles	2	Total number of times the power supply powered OFF then back ON due to loss of DC power. This is only counted when the power supply's PSON signal is asserted. This counter will stay at FFFFh once the max is reached.
	Present number of PSON power cycles	2	Total number of times the power supply is powered OFF then back ON due to the PSON signal de-asserting. This is only counted when DC power is present to the power supply. This counter will stay at FFFFh once the max is reached.
Power supply event data (N)		38	Most recent occurrence of saved black box data.
Time stamp			The power supply will track these time and power cycle counters in RAM. When the a black box event occurs the data is saved into the black box.
	Power supply total power on time	3	Total on time of the power supply in minutes. LSB = 1 minute.
	Real time clock data from system (Reserved for future use)	4	This time stamp does not need to be generated by the power supply. The system writes a real time clock value periodically to the power supply using the MFR_REAL_TIME command. Format is based on IPMI 2.0. Time is an unsigned 32-bit value representing the local time as the number of seconds from 00:00:00, January 1, 1970. This format is sufficient to maintain time stamping with 1 second resolution past the year 2100. This is based on a long standing UNIX-based standard for time keeping, which represents time as the number of seconds from 00:00:00, January 1, 1970 GMT. Similar time formats are used in ANSI C.
	Number of DC power cycles	2	Number of times the power supply powered OFF then back ON due to loss of DC power at the time of the event. This is only counted when the power supply's PSON signal is asserted.
	Number of PSON power cycles	2	Number of times the power supply is powered OFF then back ON due to the PSON signal deasserting at the time of the event. This is only counted when DC power is present to the power supply.

COMMUNICATION BUS DESCRIPTIONS

	Item	Number of Bytes	Description	
PMBus			The power supply will save these PMBus values into the black box when a black box event occurs. Fast events may be missed due to the filtering effects of the PMBus sensors.	
	STATUS_WORD	2		
	STATUS_IOUT	1		
	STATUS_INPUT	1		
	STATUS_TEMPERTATURE	1		
	STATUS_FAN_1_2	1		
	READ_VIN	2		
	READ_IIN	2		
	READ_IOUT	2		
	READ_TEMPERATURE_1	2		
	READ_TEMPERATURE_2	2		
	READ_FAN_SPEED_1	2		
	READ_PIN	2		
	READ_VOUT	2		
Event counters			The power supply will track the total number for each of the following events. These value will be saved to the black box when a black box event occurs. Once a value has reached 15, it will stay at 15 and not reset.	
	DC shutdown due to under voltage on input	Lower ½	The power supply will save a count of these critical events to non-volatile memory each time they occur. The counters will increment each time the associated STATUS bit is asserted.	
	Thermal shutdown	Upper ½		
	Over current or over power shutdown on output	Lower ½		
	General failure shutdown	Upper ½		
	Fan failure shutdown	Lower ½		
	Shutdown due to over voltage on output	Upper ½		
	Input voltage warning;no shutdown	Lower ½		The power supply will save into RAM a count of these warning events. Events are count only at the initial assertion of the event/bit. If the event persists without clearing the bit the counter will not be incremented. When the power supply shuts down it will save these warning event counters to non-volatile memory. The counters will increment each time the associated STATUS bit is asserted.
	Thermal warning; no shutdown	Upper ½		
	Output current power warning; no shutdown	Lower ½		
	Fan slow warning; no shutdown	Upper ½		
	Power supply event data (N-1)		38	
	Power supply event data (N-2)		38	
Power supply event data (N-3)		38		
Power supply event data (N-4)		38		

COMMUNICATION BUS DESCRIPTIONS

Name: MFR_REAL_TIME_BLACK_BOX
 Format: Write/Read Block with PEC (4 bytes)
 Code: DDh

The system will use this command to periodically write the real time clock data to the power supply.

Format is based on IPMI 2.0. Time is an unsigned 32-bit value representing the local time as the number of seconds from 00:00:00, January 1, 1970. This format is sufficient to maintain time stamping with 1 second resolution past the year 2100.

This is based on a long standing UNIX-based standard for time keeping, which represents time as the number of seconds from 00:00:00, January 1, 1970 GMT. Similar time formats are used in ANSI C.

Name: MFR_SYSTEM_BLACK_BOX
 Format: Write/Read Block with PEC (40 bytes). Low byte first.
 Code: DEh

The system uses this command to write the following data to the PSU.

Item	Bytes	
System top assembly number	1–10	Low bytes
System serial number	11–20	
Motherboard assembly number	21–30	
Motherboard serial number	31–40	High bytes

Name: MFR_BLACKBOX_CONFIG
 Format: Read/Write Byte with PEC
 Code: DFh

Bit	Value	Description
0	0 = disable black box function 1 = enable black box function	Writing a '1' enables the power supply with black box function. Writing a '0' disables the power supply black box function. The state of MFR_BLACKBOX_CONFIG will be saved in non-volatile memory so that it is not lost during power cycling. Intel will receive the power supply with the black box function enabled; bit 0 = '1'.

Name: MFR_CLEAR_BLACKBOX
 Format: Send Byte with PEC
 Code: E0h

The MFR_CLEAR_BLACKBOX command is used to clear all black box records simultaneously. This command is write only. There is no data byte for this command.

COMMUNICATION BUS DESCRIPTIONS

FRU (EEPROM) Data

The FRU (Field Replaceable Unit) data format is compliant with the Intel IPMI v1.0 specification.

The CSU2000ADC series uses 1 page of EEPROM for FRU purpose. A page of EEPROM contains up to 256 byte-sized data locations.

- Where:
- OFFSET -The OFFSET denotes the address in decimal format of a particular data byte within CSU2000ADC series EEPROM.
 - VALUE -The VALUE details data written to a particular memory location of the EEPROM.
 - DEFINITION -The contents DEFINITION refers to the definition of a particular data byte.

CSU2000ADC series FRU (EEPROM) Data:

OFFSET		DEFINITION (REMARKS)	SPEC VALUE	
(DEC)	(HEX)		(DEC)	(HEX)
COMMON HEADER, 8 BYTES				
0	00	FORMAT VERSION NUMBER (Common header) 7:4 - Reserved, write as 0000b 3:0 - Format version number = 1h for this specification	1	01
1	01	INTERNAL USE AREA OFFSET (Not required, do not reserve)	0	00
2	02	CHASSIS INFO AREA OFFSET (Not required, do not reserve)	0	00
3	03	BOARD INFO AREA OFFSET (Not required, do not reserve)	0	00
4	04	PRODUCT INFO AREA OFFSET	1	01
5	05	MULTI RECORD AREA OFFSET	10	0A
6	06	PAD (Not required, do not reserve)	0	00
7	07	ZERO CHECK SUM (256 - (Sum of bytes 0 to 6))	244	F4
PRODUCT INFORMATION AREA, 128 BYTES				
8	08	FORMAT VERSION NUMBER (Product Info Area) 7:4 - Reserved, write as 0000b 3:0 - Format Version Number = 1h for this specification	1	01
9	09	PRODUCT INFO AREA LENGTH (In multiples of 8 bytes)	9	09
10	0A	Language (English)	25	19
11	0B	MANUFACTURER NAME TYPE / LENGTH (C7H) 7:6 - (11)b, 8-Bit ASCII + Latin 5:0 - (000111)b, 7 bytes allocation	199	C7
12	0C	MANUFACTURER'S NAME 7 bytes sequence "A"= 41h "R"= 52h "T"= 54h "E"= 45h "S"= 53h "Y"= 59h "N"= 4Eh	65	41
13	0D		82	52
14	0E		84	54
15	0F		69	45
15	10		83	53
17	11		89	59
18	12		78	4E
19	13	PRODUCT NAME Type/Length (D0H) 7:6 - (11)b, ASCII + LATIN1 5:0 - (010000)b, 16 bytes allocation	208	D0

COMMUNICATION BUS DESCRIPTIONS

CSU2000ADC series FRU (EEPROM) Data:

OFFSET		DEFINITION (REMARKS)	SPEC VALUE	
(DEC)	(HEX)		(DEC)	(HEX)
20	14	Product Name , 16 bytes sequence "C"= 43h "R"= 52h "P"= 50h "S"= 53h "2"= 32h "0"= 30h "0"= 30h "0"= 30h "W"= 57h " " = 20h " " = 20h " " = 20h " " = 20h " " = 20h " " = 20h " " = 20h " " = 20h	67	43
21	15		82	52
22	16		80	50
23	17		83	53
24	18		50	32
25	19		48	30
26	1A		48	30
27	1B		48	30
28	1C		87	57
29	1D		32	20
30	1E		32	20
31	1F		32	20
32	20		32	20
33	21		32	20
34	22		32	20
35	23		32	20
36	24	PRODUCT PART/MODEL NUMBER Type/Length (D0H) 7:6 - (11)b, ASCII + LATIN1 5:0 - (010000)b, 16-byte allocation	208	D0
37	25	Part / Model Number "C"= 43h "S"= 53h "U"= 55h "2"= 32h "0"= 30h "0"= 30h "0"= 30h "A"= 41h "D"= 44h "C"= 43h "_"= 2Dh "3"= 23h "_"= 2Dh "1"= 31h "0"= 30h "0"= 30h	67	43
38	26		83	53
39	27		85	55
40	28		50	32
41	29		48	30
42	2A		48	30
43	2B		48	30
44	2C		65	41
45	2D		68	44
46	2E		67	43
47	2F		45	2D
48	30		51	23
49	31		45	2D
50	32		49	31
51	33		48	30
52	34		48	30
53	35	PRODUCT VERSION NUMBER Type/Length (C2h) 7:6 - (11)b, ASCII + LATIN 1 5:0 - (000010)b, 2-byte allocation	194	C2
54	36	PRODUCT VERSION NUMBER BYTES See Latest Model Rev in the label	XX	XX
55	37		XX	XX
56	38	PRODUCT SERIAL NUMBER Type/Length 7:6 - (11)b, ASCII + LATIN 1 5:0 - (001101)b, 13-byte allocation	205	CD

COMMUNICATION BUS DESCRIPTIONS

CSU2000ADC series FRU (EEPROM) Data:

OFFSET		DEFINITION (REMARKS)	SPEC VALUE	
(DEC)	(HEX)		(DEC)	(HEX)
57	39	Product Serial number See Latest Model S/N in PSU Tag	XX	XX
58	3A		XX	XX
59	3B		XX	XX
60	3C		XX	XX
61	3D		XX	XX
62	3E		XX	XX
63	3F		XX	XX
64	40		XX	XX
65	41		XX	XX
66	42		XX	XX
67	43		XX	XX
68	44		XX	XX
69	45		XX	XX
70	46	Asset Tag Type/length 7:6 - (11)b, ASCII + LATIN 1 5:0 - (000000)b, 0-byte allocation	192	C0
71	47	FRU File ID Type/length 7:6 - (11)b, ASCII + LATIN 1 5:0 - (000000)b, 0-byte allocation	192	C0
72	48	C1h (type/length byte encoded in indicate no more info fields)	193	C1
73	49	00h - any remaining unused space	0	00
74	4A	00h - any remaining unused space	0	00
75	4B	00h - any remaining unused space	0	00
76	4C	00h - any remaining unused space	0	00
77	4D	00h - any remaining unused space	0	00
78	4E	00h - any remaining unused space	0	00
79	4F	ZERO CHECK SUM (256-(sum of bytes 8 to 78)) Per Unit Zero Check Sum: should follow check sum calculation as per IPMI v1.3 specs	XX	XX
MULTI RECORD AREA, 72 BYTES				
80	50	Power Supply Record Header Record type = 00 for power supply info	0	00
81	51	End of list / Record format version number for 12V output record	2	02
82	52	Record length of 12V output record	24	18
83	53	Record checksum	NA	NA
84	54	Header checksum	NA	NA
POWER SUPPLY RECORD				
85	55	Overall Capacity of the Power Supply, 2000W = 07D0H 2 bytes sequence CSU2000 = 2000W (0x07D0) Byte 1 (LSB) = D0h = 208d Byte 2 (MSB) = 07h = 07d	208	D0
86	56		7	07
87	57	Peak VA, 2400W = 0960 2 bytes sequence Byte 1 (LSB) = 96h = 150d Byte 2 (MSB) = 09h = 9d	139	96
88	58		9	09
89	59	Inrush Current, 46A In Decimal = 46d, In Hex = 2Eh	46	2E
90	5A	Inrush Interval, 1mS In Decimal = 1d, In Hex = 01h	1	01
91	5B	Low End Input Voltage Range 1 (10mV), (40V/10mV) 4000 = 0FA0h 2 bytes sequence Byte 1 (LSB) = A0h = 160d Byte 2 (MSB) = 0Fh = 15d	160	A0
92	5C		15	0F

COMMUNICATION BUS DESCRIPTIONS

CSU2000ADC series FRU (EEPROM) Data:

OFFSET		DEFINITION (REMARKS)	SPEC VALUE	
(DEC)	(HEX)		(DEC)	(HEX)
93	5D	High End Input Voltage Range 1 (10mV), (72V/10mV) 7200 = 1C20H 2 bytes sequence Byte 1 (LSB) = 20h = 32d Byte 2 (MSB) = 1Ch = 28d	32	20
94	5E		28	1C
95	5F	Low End Input Voltage Range 2 (10mV), (Zero if single range) (signed)	0	00
96	60		0	00
97	61	High End Input Voltage Range 2 (10mV), (Zero if single range) (signed)	0	00
98	62		0	00
99	63	Low End Input Frequency Range, 00Hz = 00h	0	00
100	64	Low End Input Frequency Range, 00Hz = 00h	0	00
101	65	DC Dropout Tolerance in ms, 1mS = 01H	01	01
102	66	Binary Flags: For each of the following binary flags No = 0, Yes = 1. Bits 7-5: RESERVED, Write as 000b Bit4: Tachometer Pulses Per Rotation / Predictive Fail Polarity BIT = 0 Bit3: Hot Swap / Redundancy Support BIT = 1 Bit2: Auto switch Support BIT = 1 Bit1: Power Factor Correction Support BIT = 1 Bit0: Predictive Fail Support BIT = 0	14	0E
103	67	Peak Wattage Capacity and Holdup Time, (Set for 2200Watts/15S) 15:12 - Hold up time in seconds 11:0 - Peak capacity (watts) (LSB First) In Decimal = 152 In Hex = 98H (LSB First) In Decimal = 248 In Hex = F8H	152	98
104	68		248	F8
105	69	Combined Wattage, No Combined voltage for power supply	0	00
106	6A		0	00
107	6B		0	00
108	6C	Predictive Fail Tachometer Lower Threshold, Not Applicable. Predictive failure is not supported.	0	00
12V OUTPUT RECORD HEADER				
109	6D	Record Type = 09 for DC Output Record	9	09
110	6E	End of List / Record Format Version Number for 12V Output Record	2	02
111	6F	Record Length of 12V Output Record	13	0D
112	70	Record checksum (256-(sum of bytes 114 to 126))	NA	NA
113	71	Header checksum (256-(sum of bytes 109 to 112))	NA	NA
12V OUTPUT RECORD				
114	72	Output Information, 001 = 01H Bit 7: Standby information = 0b Bits 6-5: Reserved, write as 000b Bits 4: Current units, 0b = 10mA Bits 3-0: Output number 1 = 001b	1	01
115	73	Nominal Voltage (10mV), (12.2V / 10mV) 1220 = 04C4H 2 bytes sequence In Decimal: 196d, 4d In Hex: C4H, 04H	196	C4
116	74		4	04

COMMUNICATION BUS DESCRIPTIONS

CSU2000ADC series FRU (EEPROM) Data:

OFFSET		DEFINITION (REMARKS)	SPEC VALUE	
(DEC)	(HEX)		(DEC)	(HEX)
117 118	75 76	Maximum Negative Voltage Deviation (11.6V / 10mV) , 1160 = 0488H 2 bytes sequence In Decimal: 136d, 004d In Hex: 88H, 04H	136 4	88 04
119 120	77 78	Maximum Positive Voltage Deviation (12.8V / 10mV) , 1280 = 0500H 2 bytes sequence In Decimal: 000d, 005d In Hex: 00H, 05H	00 05	00 05
121 122	79 7A	Ripple and Noise pk-pk (mV) , 120 = 78H 2 bytes sequence In Decimal: 120d, 000d In Hex: 78H, 00H	120 0	78 00
123 124	7B 7C	Minimum Current Draw (10mA) , 0mA = 0000H 2 bytes sequence In Decimal: 0d, 0d In Hex: 00H, 00H	0 0	00 00
125 126	7D 7E	Maximum Current Draw (164A/10mA) , 16400 = 4010H 2 bytes sequence In Decimal: 16d, 64d In Hex: 10H, 40H	16 64	10 40
12VSB OUTPUT RECORD HEADER				
127	7F	Record type = 01 for DC Output Record	01	01
128	80	End of List / Record Format Version Number for 12V _{SB} Output Record	130	82
129	81	Record Length of 12V DC Output Record	13	0D
130	82	Record CHECKSUM of 12V _{SB} Output Record	NA	NA
131	83	Header CHECKSUM of 12V _{SB} Output Record Header	NA	NA
12VSB OUTPUT RECORD				
132	84	Output Information , 130 = 82H Bit 7: Standby Information = 1b Bits 6-4: Reserved, write as 000b Bits 3-0: Output number 2 = 0010b	130	82
133 134	85 86	Nominal Voltage (10mV) , (12V / 10mV) 1200 = 04B0H 2 bytes sequence In Decimal: 176d, 004d In Hex: B0H, 04H	176 4	B0 04
135 136	87 88	Maximum Negative Voltage Deviation (10mV) , 1140 = 0474H 2 bytes sequence In Decimal: 116d, 004d In Hex: 74H, 04H	116 04	74 04
137 138	89 8A	Maximum Positive Voltage Deviation (10mV) , 1260 = 04ECH 2 bytes sequence In Decimal: 236d, 004d In Hex: ECH, 04H	236 4	EC 04
139 140	8B 8C	Ripple and Noise pk-pk (mV) , 120 = 78H 2 bytes sequence In Decimal: 120d, 000d In Hex: 78H, 00H	120 0	78 00
141 142	8D 8E	Minimum Current Draw (10mA) , 0000 = 0000H 2 bytes sequence In Decimal: 000d, 000d In Hex: 00H, 00H	0 0	00 00

COMMUNICATION BUS DESCRIPTIONS

CSU2000ADC series FRU (EEPROM) Data:

OFFSET		DEFINITION	SPEC VALUE	
(DEC)	(HEX)	(REMARKS)	(DEC)	(HEX)
143	8F	Maximum Current Draw (10mA), 3500 = 0DACH 2 Bytes Sequence In Decimal: 172d, 13d In Hex: ACH, 0DH	172	AC
144	90		13	0D
145	91	Reversed, Default value is 0.	0	00
146	92	Reversed, Default value is 0.	0	00
147	93	Reversed, Default value is 0.	0	00
148	94	Reversed, Default value is 0.	0	00
149	95	Reversed, Default value is 0.	0	00
150	96	Reversed, Default value is 0.	0	00
151	97	Reversed, Default value is 0.	0	00
152	98	(98h-FFh is reserved. Default value is 0.)	0	00
153	99		0	00
154	9A		0	00
155	9B		0	00
156	9C		0	00
157	9D		0	00
158	9E		0	00
159	9F		0	00
160	A0		0	00
161	A1		0	00
162	A2		0	00
163	A3		0	00
164	A4		0	00
165	A5		0	00
166	A6		0	00
167	A7		0	00
168	A8		0	00
169	A9		0	00
170	AA		0	00
171	AB		0	00
172	AC		0	00
173	AD		0	00
174	AE		0	00
175	AF		0	00
176	B0		0	00
177	B1		0	00
178	B2		0	00
179	B3		0	00
180	B4		0	00
181	B5		0	00
182	B6		0	00
183	B7	0	00	
184	B8	0	00	
185	B9	0	00	
186	BA	0	00	
187	BB	0	00	
188	BC	0	00	
189	BD	0	00	
190	BE	0	00	
191	BF	0	00	
192	C0	0	00	
193	C1	0	00	
194	C2	0	00	
195	C3	0	00	
196	C4	0	00	
197	C5	0	00	
198	C6	0	00	

COMMUNICATION BUS DESCRIPTIONS

CSU2000ADC series FRU (EEPROM) Data:

OFFSET		DEFINITION (REMARKS)	SPEC VALUE	
(DEC)	(HEX)		(DEC)	(HEX)
199	C7	(98h-FFh is reserved. Default value is 0.)	0	00
200	C8		0	00
201	C9		0	00
202	CA		0	00
203	CB		0	00
204	CC		0	00
205	CD		0	00
206	CE		0	00
207	CF		0	00
208	D0		0	00
209	D1		0	00
210	D2		0	00
211	D3		0	00
212	D4		0	00
213	D5		0	00
214	D6		0	00
215	D7		0	00
216	D8		0	00
217	D9		0	00
218	DA		0	00
219	DB		0	00
220	DC		0	00
221	DD		0	00
222	DE		0	00
223	DF		0	00
224	E0	0	00	
225	E1	0	00	
226	E2	0	00	
227	E3	0	00	
228	E4	0	00	
229	E5	0	00	
230	E6	0	00	
231	E7	0	00	
232	E8	0	00	
233	E9	0	00	
234	EA	0	00	
235	EB	0	00	
236	EC	0	00	
237	ED	0	00	
238	EE	0	00	
239	EF	0	00	
240	F0	0	00	
241	F1	0	00	
242	F2	0	00	
243	F3	0	00	
244	F4	0	00	
265	F5	0	00	
246	F6	0	00	
247	F7	0	00	
248	F8	0	00	
249	F9	0	00	
250	FA	0	00	
251	FB	0	00	
252	FC	0	00	
253	FD	0	00	
254	FE	0	00	
255	FF	0	00	

PMBUS™ SPECIFICATIONS

The CSU2000ADC series is compliant with the industry standard PMBus™ protocol for monitoring and control of the power supply via the I²C interface port.

CSU2000ADC Series PMBus™ General Instructions

Equipment Setup

The following is typical I²C communication setup:

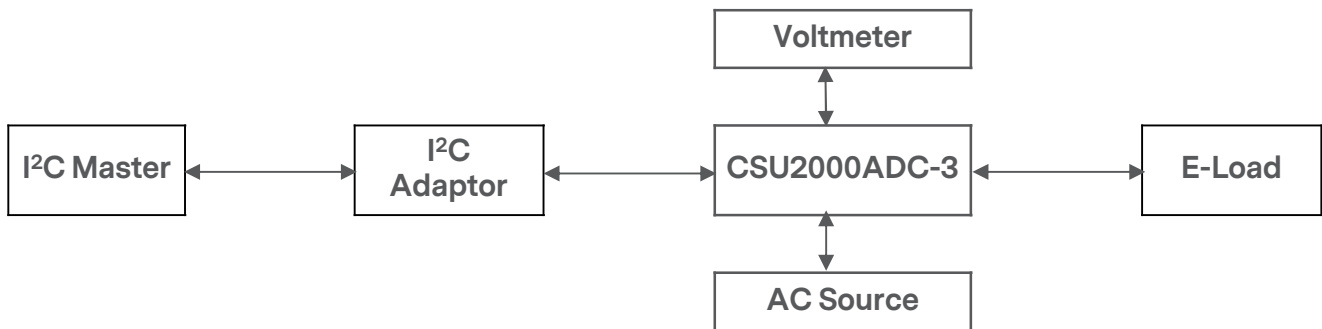

PMBus™ Reporting Accuracy

Output Load	Input Voltage	Input Current	Input Power	Output Voltage	Output Current	Output Power	Temperature	Fan speed
40W to 150W	±3%	±0.3A	±10W	±3%	±1A	±10W	±3°C	±500RPM
150W to 300W	±3%	±5%	±10W	±3%	±5%	±5%	±3°C	±500RPM
300W to full load	±2%	±2%	±2%	±2%	±2%	±2%	±3°C	±500RPM

PMBUS™ SPECIFICATIONS

The CSU2000ADC Series Supported PMBus™ Command List:

Command Code	Command Name	Default Value	Access Type	Data Bytes	Data Format	Description
00h	PAGE	00	R	1	Hex	Valid input: 00h
01h	OPERATION	80	R/W	1	Bitmapped	Used to turn the unit ON/OFF. Valid input: 80h, 40h
	b7:6	10				01 - PSU OFF 10 - PSU ON
	b5:0	000000				Reserved
03h	CLEAR_FAULTS		S		N/A	Page Support If the page is set to FFh, both BMC and ME STATUS bits are cleared.
05h	PAGE_PLUS_WRITE		BW		N/A	
06h	PAGE_PLUS_READ		BR		N/A	
19h	CAPABILITY	90	R	1	Bitmapped	Provides a way for the hosts system to determine some key capabilities of a PMBus™ device.
	b7 - Packet Error Checking	1				0 - PEC not supported 1 - PEC supported
	b6:5 - Maximum Bus Speed	00				00 - Maximum supported bus speed, 100KHz 01 - Maximum supported bus speed, 400KHz 10 - Maximum supported bus speed, 1MHz 11 - Reserved
	b4 - SMBALERT#	1				0 - SMBus Alert Pin not supported 1 - SMBus Alert Pin supported
	b3 - Numeric Format	0				0 - Linear11, Ulinear16, Slinear16, or Direct 1 - IEEE half precision floating point format
	b2 - AVSBus	0				0 - AVSBus not supported 1 - AVSBus supported
	b1:0	00				Reserved
1Ah	QUERY	-	BR/BW		N/A	Supported in ISP mode
1Bh	SMBALERT_MASK	-	BR/BW		N/A	Default masks per Intel spec: Page 00: STATUS_VOUT = FFh STATUS_IOUT = FFh STATUS_INPUT = FFh STATUS_TEMP = FFh STATUS_CML = FFh Page 01: STATUS_VOUT = FFh STATUS_IOUT = DFh STATUS_INPUT = EFh STATUS_TEMP = BFh STATUS_CML = FFh Non-paged: STATUS_FANS_1_2 = FFh
20h	VOUT_MODE	17	R	1	Bitmapped	Specifies the mode and parameters of output voltage related data formats

PMBUS™ SPECIFICATIONS

The CSU2000ADC Series Supported PMBus™ Command List:

Command Code	Command Name	Default Value	Access Type	Data Bytes	Data Format	Description
30h	COEFFICIENTS		BW/BR	5	Hex	Use to retrieve the m, b and R coefficients, needed for DIRECT data format.
	byte 5	00				R byte
	byte 4:3	0000				b low Byte, b high byte
	byte 2:1	0000				m low Byte, m high byte
3Ah	FAN_CONFIG_1_2	90	R/W	1	Bitmapped	Default RPM Mode.
	b7	1				0 - No fan is installed in position 1. 1 - Fan is installed in position 1.
	b6	0				0 - Fan is commanded in DC. 1 - Fan is commanded is RPM.
	b5:4	01				00 - 1 pulse per revolution 01 - 2 pulse per revolution 10 - 3 pulse per revolution 11 - 4 pulse per revolution
	b3:0	0000				Reserved
3Bh	FAN_COMMAND_1	0000	R/W	2	Linear	Adjusts the operation of the Fans in duty cycle. The device may override the command, if it requires higher value to maintain proper device temperature.
4Ah	IOUT_OC_WARNING_LIMIT	00B9	R	2	Linear	Sets the over current warning threshold in Amps. (185.00A)
51h	OT_WARN_LIMIT (Hot Spot)	0073	R	2	Hex	Secondary ambient temperature warning threshold, in degree C. Operating limit (115degC)

PMBUS™ SPECIFICATIONS

The CSU2000ADC Series Supported PMBus™ Command List:

Command Code	Command Name	Default Value	Access Type	Data Bytes	Data Format	Description
79h	STATUS_WORD	-	R	2	Bitmapped	Summary of units fault and warning status.
	b15 - VOUT					An output voltage fault or warning has occurred.
	b14 - IOUT					An output current or power fault or warning has occurred.
	b13 - INPUT					An input voltage, current or power fault or warning has occurred.
	b11 - POWER_GOOD#					The POWER_GOOD signal is de-asserted.
	b10 - FANS					Use STATUS_FANS_1_2
	b6 - OFF					Unit is OFF.
	b5 - VOUT_OV_FAULT					Output over-voltage fault has occurred.
	b4 - IOUT_OC_FAULT					Output over-current fault has occurred.
	b3 - VIN_UV_FAULT					An input under-voltage fault has occurred.
	b2 - TEMPERATURE					A temperature fault or warning has occurred.
	b1 - CML					A communication, memory or logic fault has occurred.
7Ah	STATUS_VOUT	-	R	1	Bitmapped	
	b7 - VOUT Over-Voltage Fault	-				VOUT Over-Voltage Fault
	b4 - VOUT Under-Voltage Fault	-				VOUT Under-Voltage Fault
7Bh	STATUS_IOUT		R	1	Bitmapped	
	b7 - IOUT Overcurrent Fault					IOUT Overcurrent Fault
	b5 - IOUT Overcurrent Warning					IOUT Overcurrent Warning
	b1 - POUT_OP_FAULT					POUT_OP_FAULT
	b0 - POUT_OP_WARNING					POUT_OP_WARNING
7Ch	STATUS_INPUT		R	1	Bitmapped	Input related faults and warnings
	b7 - VIN_OV_FAULT					VIN over-voltage fault
	b5 - VIN_UV_WARNING					VIN under-voltage warning
	b4 - VIN_UV_FAULT					VIN under-voltage fault
	b3 - Unit Off For Low Input Voltage					Unit is Off for insufficient input voltage.
	b1 - IIN_OC_WARNING					IIN Overcurrent warning
	b0 - PIN_OP_WARNING					PIN Overpower warning
7Dh	STATUS_TEMPERATURE		R	1	Bitmapped	Temperature related faults and warnings
	b7 - Over Temperature Fault					Over temperature fault
	b6 - Over Temperature Warning					Over temperature warning

PMBUS™ SPECIFICATIONS

The CSU2000ADC Series Supported PMBus™ Command List:

Command Code	Command Name	Default Value	Access Type	Data Bytes	Data Format	Description
7Eh	STATUS_CML		R	1	Bitmapped	Communications, logic and memory
	b7 - Invalid/Unsupported command					Invalid or unsupported command received
	b6 - Invalid/Unsupported Data					Invalid data
	b5 - Packet Error Check Failed					Packet error check failed
80h	STATUS_MFR_SPECIFIC		R	1	Hex	00h - No input 01h - AC input 02h - DC input
81h	STATUS_FANS_1_2		R	1	Bitmapped	
	b7 - Fan1 Fault					Fan1 Fault
	b5 - Fan1 Warning					Fan1 Warning
86h	Ein		BR	6	Direct	Returns the accumulated input power over time.
87h	Eout		BR	6	Direct	Returns the accumulated output power over time.
88h	READ_VIN		R	2	Linear	Returns input voltage in Volts ac.
89h	READ_IIN		R	2	Linear	Returns input current in Amperes.
8Bh	READ_VOUT		R	2	Linear	Returns the actual, measured voltage in Volts.
8Ch	READ_IOUT		R	2	Linear	Returns the output current in amperes.
8Dh	READ_TEMPERATURE_1		R	2	Linear	Returns the inlet temperature in degree Celsius.
8Eh	READ_TEMPERATURE_2		R	2	Linear	Returns the primary hot pot temperature in degree Celsius.
8Fh	READ_TEMPERATURE_3		R	2	Linear	Returns the secondary hot pot temperature in degree Celsius.
90h	READ_FAN_SPEED_1		R	2	Linear	Speed of fan 1
96h	READ_POUT		R	2	Linear	Returns the output power, in Watts.
97h	READ_PIN		R	2	Linear	Returns the input power, in Watts.
98h	PMBUS_REVISION	22	R	1	Bitmapped	Reads the PMBus revision number.
	b7:5	0010				Part 1 Revision 0000 - Revision 1.0 0001 - Revision 1.1 0010 - Revision 1.2
	b4:0	0010				Part 2 Revision 0000 - Revision 1.0 0001 - Revision 1.1 0010 - Revision 1.2
99h	MFR_ID	ARTESYN (0x41 52 54 45 53 59 4E 20 20 20 20 20 20 20)	BR	14	ASCII	Supported in ISP mode linked to FRU Default: "ARTESYN"

PMBUS™ SPECIFICATIONS

The CSU2000ADC Series Supported PMBus™ Command List:

Command Code	Command Name	Default Value	Access Type	Data Bytes	Data Format	Description
9Ah	MFR_MODEL	CSU2000ADC-3-100 (0x43 53 55 32 30 30 30 41 44 43 2D 33 2D 31 30 30)	BR	16	ASCII	Supported in ISP mode linked to FRU Model number matching label.
9Bh	MFR_REVISION		BR	6	ASCII	Linked to FRU Format "XX;"
9Ch	MFR_LOCATION	CHINA (0x43 48 49 4E 41 20 20 20 20 20 20 20 20 20 20)	BR	16	ASCII	
9Dh	MFR_DATE		BR	8	ASCII	
9Eh	MFR_SERIAL		BR	15	ASCII	Linked to FRU
A6h	MFR_IOUT_MAX	F290	R	2	Linear	Maximum output current (164A)
A7h	MFR_POOUT_MAX	11F4	R	2	Linear	Maximum output power (2000W)
C0h	MFR_MAX_TEMP_1 (Ambient)	EA08	R	2	Linear	Maximum ambient temperature (65degC)
C1h	MFR_MAX_TEMP_2 (hot Spot)	EBE8	R	2	Linear	Maximum hot spot temperature (125degC)
D0h	Cold_Redundancy_Config	00	R/W	1	Hex	00 - Normal 01 - Active 02 - Cold standby 1 03 - Cold standby 2 04 - Cold standby 3 05 - Always cold standby
DDh	MFR_REAL_TIME_BLACK_BOX		BR/BW	4		
DEh	MFR_SYSTEM_BLACK_BOX		BR/BW	40		
DFh	MFR_BLACKBOX_CONFIG		R/W			
E0h	MFR_CLEAR_BLACKBOX		W			

PMBUS™ SPECIFICATIONS

The CSU2000ADC Series Firmware Update Command List:
 The power supply uses the following commands during the bootload process.

Command Code	Command Name	Default Value	Access Type	Data Bytes	Description
D4h	MFR_HW_COMPATIBILITY	-	R	-	This is a COMPATIBILITY value used to tell if there are any changes in the FW that create an incompatibility with the FW. This value only changes when the PSU HW is changed creating an incompatibility with older versions of FW.
D5h	MFR_FWUPLOAD_CAPABILITY	-	R	-	The system can read the power supply's FW upload mode capability using this command. For any given power supply, more than one FW upload mode may be supported. The supported FW upload mode(s) must support updating all available FW in the power supply. This power supply supports FW uploading in standby mode only. Bit 0: "1" FW uploading in standby mode only All other bits configurations are not supported.
D6h	MFR_FWUPLOAD_MODE	-	R/W	-	Writing a "1" puts the power supply into firmware upload mode and gets it ready to receive the first image block via the MFR_FW_UPLOAD command. The system can use this command at any time to restart sending the FW image. Writing a "0" puts the power supply back into normal operating mode. Writing a "1" restart. This command will put the PSU into standby mode if the PSU supports FW update in standby mode only. If the power supply image passed to the PSU is corrupt the power supply will stay in firmware upload mode even if the system requested the PSU to exit the FW upload mode. Value: 0 = Exit firmware upload mode 1 = Firmware upload mode
D7h	MFR_FWUPLOAD	-	BW	-	Command used to send each block of the FW image.
D8h	MFR_FWUPLOAD_STATUS	-	R	2	At any time during or after the firmware image upload the system can read this command to determine status of the firmware upload process. All bits get reset to "0" when the power supply enters FW upload mode. Bit 0: "1" full image received Bit 1: "1" full image not received. This remains asserted until the full image is received Bit 2: "1" bad or corrupt image received Bit 3: For future use Bit 4: "1" FW image is not supported and not received Bit 5-15: Reserved
D9h	MFR_FW_REVISION	NA	BR	3	Supported in ISP mode Label vAA.BB.CC returns 0xCCBBAA.

Noted: While the PSU FW image is being updated the PSU will blink the green LED at a 2Hz rate.

PMBUS™ SPECIFICATIONS

Firmware Update Process

BMC uses these commands to determine if FW needs updating:
 MFR_FW_REVISION
 MFR_MODEL
 MFR_FW_UPLOAD_MODE
 MFR_HW_COMPATIBILITY
 MFR_FW_UPLOAD_CAPABILITY

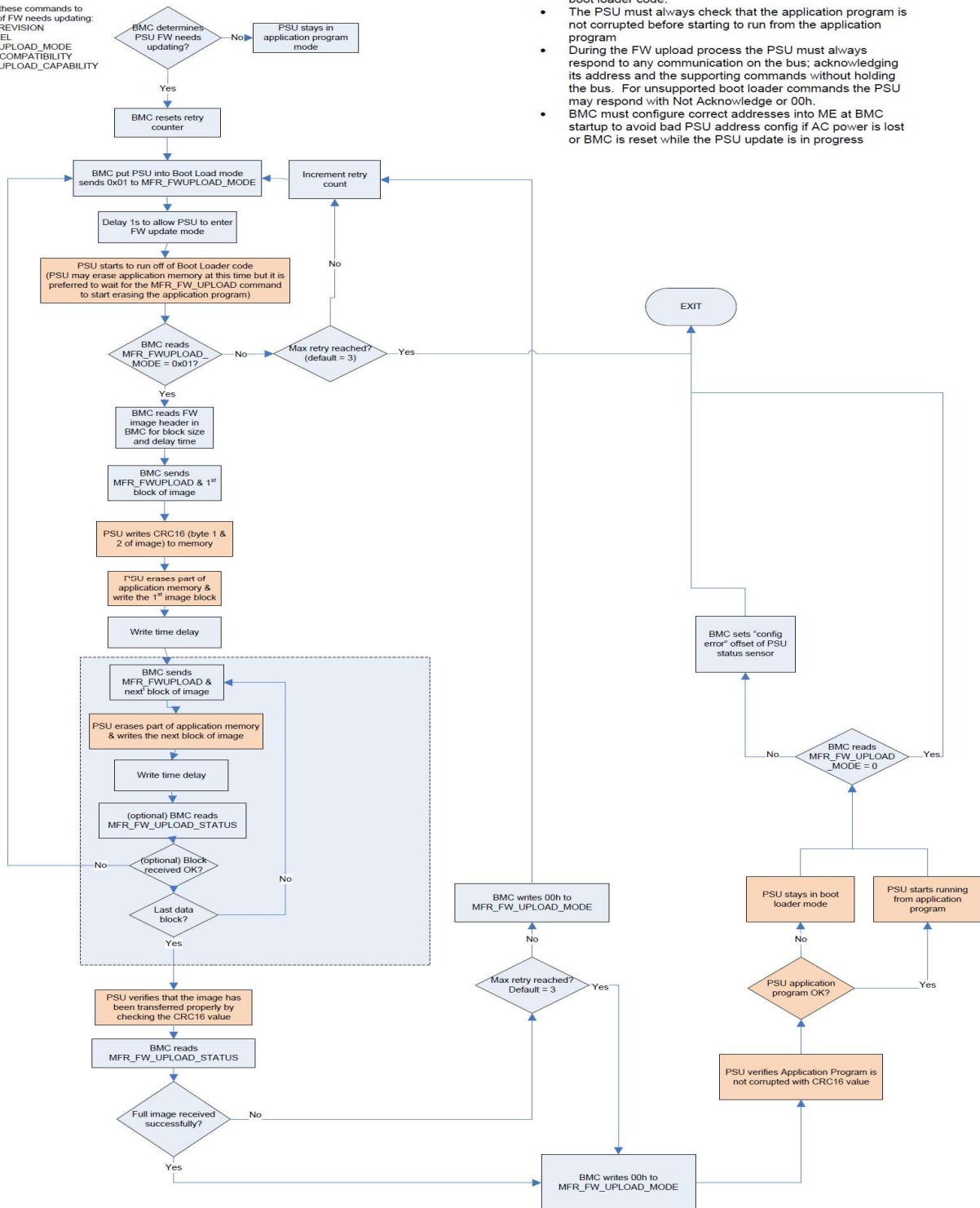

IMPORTANT!

- PSU may be in standby mode or ON mode during FW update process
- If the FW update process is interrupted at any point during the process; the PSU must always be able to return to the boot loader code.
- The PSU must always check that the application program is not corrupted before starting to run from the application program
- During the FW upload process the PSU must always respond to any communication on the bus; acknowledging its address and the supporting commands without holding the bus. For unsupported boot loader commands the PSU may respond with Not Acknowledge or 00h.
- BMC must configure correct addresses into ME at BMC startup to avoid bad PSU address config if AC power is lost or BMC is reset while the PSU update is in progress

PMBUS™ SPECIFICATIONS

PSU Flow During Powering ON

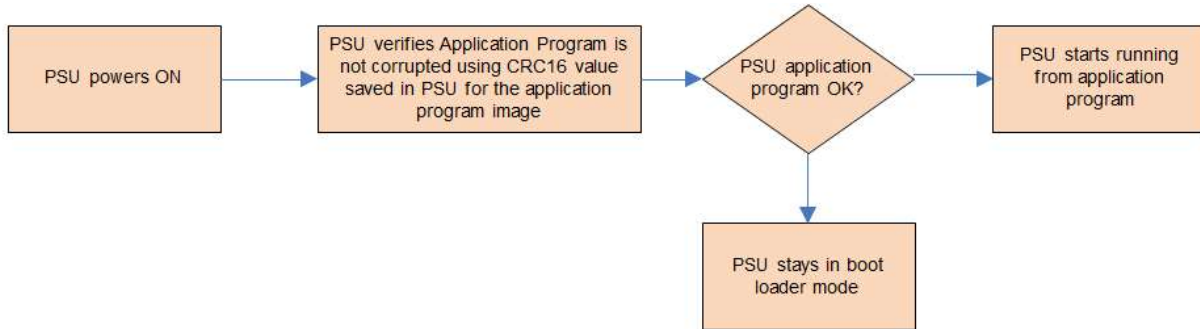

APPLICATION NOTES

Current Sharing

The CSU2000ADC series main output V_O is equipped with current sharing capability. This will allow up to 3+1 power supplies to be connected in parallel for higher power application. Current share accuracy is typically 6% when the load is larger than 25%. Below 7% total loading, there is no guarantee of output current sharing.

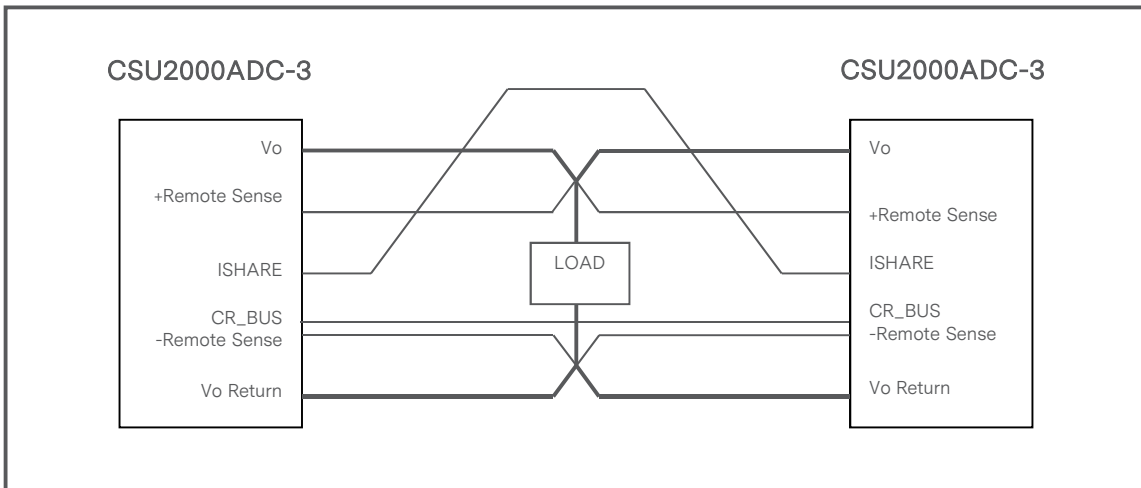

APPLICATION NOTES

Output Ripple and Noise Measurement

The setup outlined in the diagram below has been used for output voltage ripple and noise measurements on the CSU2000ADC series power supply. When measuring output ripple and noise, a scope jack in parallel with a 0.1 μ F ceramic chip capacitor, and a 10 μ F tantalum capacitor will be used. Oscilloscope can be set to 20MHz bandwidth for this measurement.

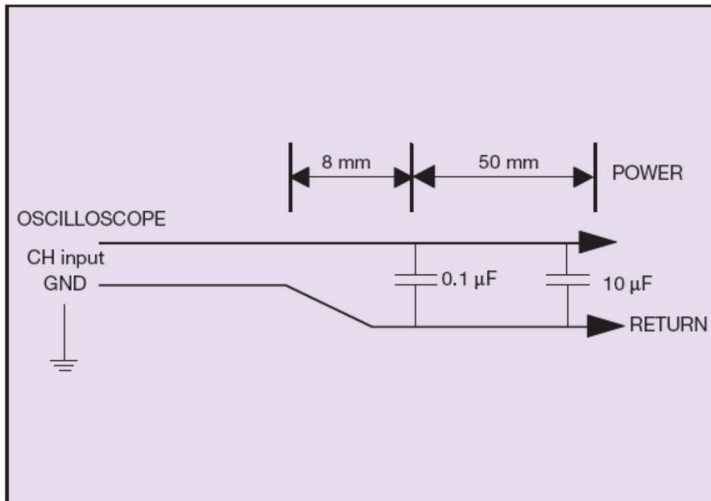

RECORD OF REVISION AND CHANGES

Issue	Date	Description	Originators
1.0	04.30.2021	First Issue	A. Zhang
1.1	08.11.2021	Update the PMBus™ command 9Ch and 9Dh	A. Zhang
1.2	10.11.2021	<ol style="list-style-type: none"> 1. Add IEC 60950 and IEC 62368 on page 1 2. Add ecap life on page 3 3. Add acoustic table on page 16 4. Add notes for thermal derating curve 	A. Zhang
1.3	12.01.2021	Update EMC and safety	A. Zhang
1.4	02.11.2022	Update output mating connector Update 99h and 9Ah default value per test	A. Zhang K. Wang
1.5	03.26.2022	Update PMBus™ status commands	A. Zhang



For international contact information,
visit advancedenergy.com.

powersales@aei.com (Sales Support)
productsupport.ep@aei.com (Technical Support)
+1 888 412 7832

ABOUT ADVANCED ENERGY

Advanced Energy (AE) has devoted more than three decades to perfecting power for its global customers. AE designs and manufactures highly engineered, precision power conversion, measurement and control solutions for mission-critical applications and processes.

Our products enable customer innovation in complex applications for a wide range of industries including semiconductor equipment, industrial, manufacturing, telecommunications, data center computing, and medical. With deep applications know-how and responsive service and support across the globe, we build collaborative partnerships to meet rapid technological developments, propel growth for our customers, and innovate the future of power.

PRECISION | POWER | PERFORMANCE

Specifications are subject to change without notice. Not responsible for errors or omissions. ©2020 Advanced Energy Industries, Inc. All rights reserved. Advanced Energy®, and AE® are U.S. trademarks of Advanced Energy Industries, Inc.