

SL POWER TF1500 SERIES

1500 Watts Single Output
Industrial Grade



AT A GLANCE

Total Power

Up to 1500 Watts

Input Voltage

90 to 264 VAC

of Outputs

Single

Advanced Energy's SL Power TF1500 series of industrial grade AC-DC fan-cooled power supply comprises seven output models. All models feature industrial safety approvals and accept a universal input of 90 to 264 VAC. These compact switch-mode power supplies feature output overvoltage, overtemperature, overload protection, with short-circuit protection on all output models. TF1500 series power supplies provide up to 1500 Watts of output power with remote setting multiple PSU and global control function.

SPECIAL FEATURES

- Universal Input 90 to 264 VAC Input Range
- 1500 W Fan-Cooled (Load & Temperature Controlled)
- Programmable Output Voltage (0% to 105%)
- Programmable Output Current (0% to 105%)
- Forced Current Sharing at Parallel Operation
- Constant Current Limit
- Selectable +5 V/0.5 A or +9 V/0.3 A Auxiliary Output
- Remote Setting Multiple PSU via RS232, RS485 & I²C
- Power OK Signal
- Remote ON/OFF, Remote Sense Function

- Protection: OVP, OLP, OTP, Fan Failure
- 3 Year Warranty
- Global Control via RS232
- Conformal Coating Applied



SAFETY

- CSA/IEC/EN/UL62368-1

ELECTRICAL SPECIFICATIONS

Input	
Input Voltage and Frequency ¹	90 to 264 VAC, 47 to 63 Hz, 1Ø 127 to 370 VDC
Input Current	18 A @ 115 VAC, 9 A @ 230 VAC
Inrush Current	30 A/115 VAC, 60 A/230 VAC
Efficiency	See Model Selection Table
Power Factor	0.95/230 VAC, 0.98/115 VAC at full load
Leakage Current	<2.5 mA/240 VAC
Output	
Output Voltage	See Model Selection Table
Output Power ¹	1500 W continuous - See models chart for specific voltage model ratings
Voltage Range	±5.0% typical adjustment by potentiometer (VR1)
Voltage Tolerance	See Model Selection Table
Hold-Up Time	14 mS/230 VAC at full load
Turn On Time	800 mS
Rise Time	100 mS at full load
Ripple and Noise	See Model Selection Table
Line/Load Regulation	See Model Selection Table
Auxiliary Signals	
Auxiliary Power	Selectable +5 V/0.5 A or +9 V/0.3 A auxiliary output
Remote On / Off Control	By external switch
Power Ok Signa	Open drain signal low when PSU turns on. Max sink current: 20 mA. Max drain voltage: 40 V
Output Voltage Trim	Adjustment of output voltage is between 0 to 105% of rated output
Output Current Trim	Adjustment of output voltage is between 0 to 105% of rated output
Parallel (Current Sharing) ²	Please refer to current sharing with remote sensing (parallel connection) diagram
Reliability	
MTBF	>112,000 hours per MIL-HDBK-217F
Protection	
Overvoltage Protection	120±7% of Vout, latch type (Recovery after reset AC power ON or inhibit) (Refer to VCI vs. OVP Curve)
Short Circuit Protection	Constant current, auto-recovery
Overload Protection	105% of rated power, constant current type
Overtemperature Protection	85±5°C measured on NTC, auto-recovery
Safety	
Safety Certifications	Approved to EN/CSA/IEC/UL62368-1
Isolation Specifications	
Isolation ³	Input-Output: 3000 VAC Input-Ground: 1500 VAC Output-Ground: 500 VAC
Isolation Resistance	I/P-O/P, I/P-FG, O/P-FG: 100 Mohms/500 VDC

Notes:

1. Derating may apply in low input voltage. Please check the derating curve for details.
2. In parallel connection only one unit will operate if the total output load is less than 5% of the rated power.
3. This test is done without enclosure: I/P-O/P 4242 VDC. If with enclosure: I/P-O/P 2121 VDC, I/P-FG: 2121 VDC, O/P-FG: 707 VDC

EMI/EMC COMPLIANCE

Conducted Emissions	Certified EN55022; EN61204-3; EN61000-6-3
Radiated Emissions	Certified EN55022; EN61204-3; EN61000-6-3
Electro-Static Discharge (ESD) Immunity On Power Ports	EN55024/IEC61000-4-2
Radiated RF EM Fields Susceptibility	EN55022/EN61000-4-3
Electrical Fast Transients (EFT)/Burst	EN55024/IEC61000-4-4
Surges, Line to Line (Diff Mode) and Line to Gnd (CMN Mode)	EN55024/IEC61000-4-5
Conducted Disturbances Induced by RF Fields	EN55022/IEC61000-4-6
Rated Power Frequency Magnetic Fields	EN55024/IEC1000-4-8
Voltage Interruptions, Dips, Sags & Surges	EN55024/IEC/EN61000-4-11
Harmonic Current Emissions	EN61000-3-2
Flicker Test	EN61000-3-3

Note:

The power supply is considered a component which will be installed into a final equipment. The final equipment must be re-confirmed that it still meets EMC directives.

ENVIRONMENTAL SPECIFICATIONS

Operating Temperature	-25°C to +60°C (Refer to load de-rating curve)
Temperature Derating	See derating curve
Vibration	10 to 500 Hz, 2 G 10 min./1 cycle, period for 60 min. each along X, Y, Z axes Compliance to IEC68-2-6, IEC68-2-64
Dimensions	127 x 64 x 280 mm (5.0 x 2.5 x 11.02 in)
Cooling	Load and temperature control fan
Relative Humidity	20% to 90%, non-condensing
Storage Temperature and Humidity	-40 to +85°C, 10 to 95% RH
Weight & Packing	2.6 kg 6 pcs/carton, 16.6 kg/1.86 CUFT

CONNECTOR INFORMATION

	Input Connector	Output Connector	Signal Connector
Pinout	Term. 1) AC LINE Term. 2) NEUTRAL Term. 3) GROUND	+ and -	See Signal Connector table on pg 4
Mating Connector/Terminal	#10 wire lugs	1/4-20 wire lugs	Connector: JST PHDR-24VS or equivalent Pins: JST SPHD-002T-P0.5 or equivalent

MECHANICAL DRAWING

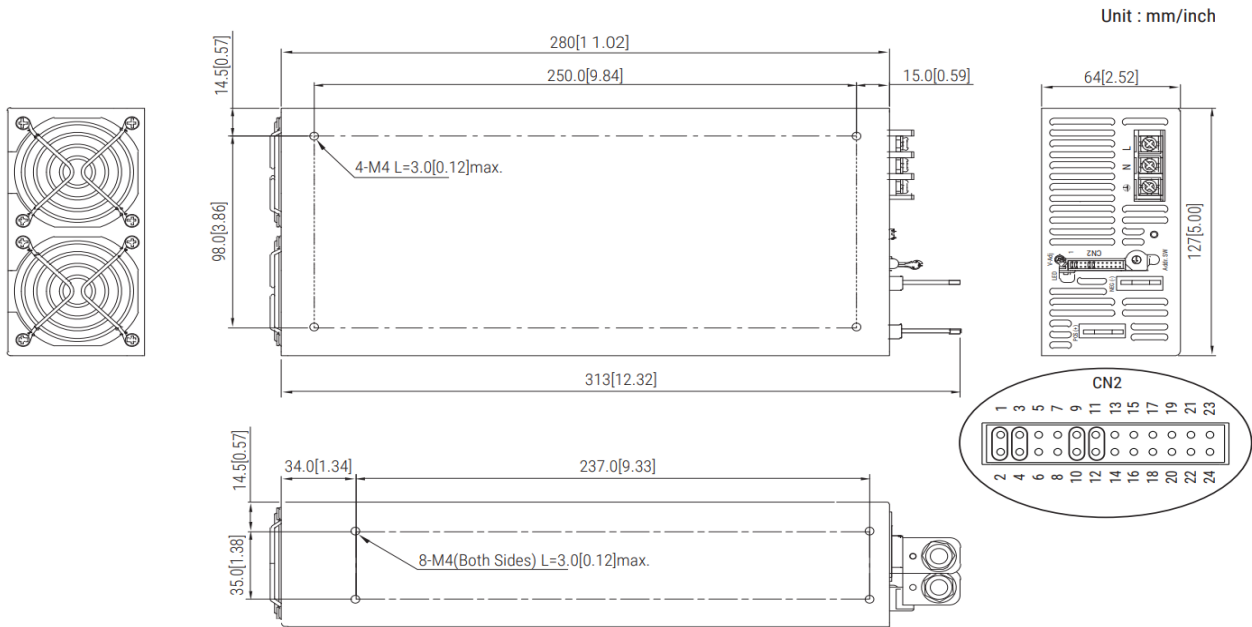

Recommended screw length is measured from the power supply surface.

SIGNAL CONNECTOR

Pin No.	Function	Description	Pin No.	Function	Description
1	VS+	Remote sense (+)	13	ACI	I Program
2	VO+	Positive output voltage	14	GND	Ground
3	VS-	Remote sense (-)	15	VCI	V Program
4	VO-	Negative output voltage	16	GND	Ground
5	POK	Power OK	17	AUX	+5 V/0.5 A or +9 V/0.3 A auxiliary power
6	GND	Ground	18	GND	Ground
7	PAR	Parallel operation current share	19	SCL	Serial clock used in the I ² C interface
8	VSET	Aux output setting	20	SDA	Serial data used in the I ² C interface
9	EN-	Inhibit ON/OFF (-)	21	AUX	+5 V/0.5 A or +9 V/0.3 A auxiliary power
10	GND	Ground	22	GND	Ground
11	EN+	Inhibit ON/OFF (+)	23	RX	For RS232 receiver function
12	AUX	+5 V/0.5 A or +9 V/0.3 A auxiliary power	24	TX	For RS232 transmission function

MODEL SELECTION

Model Number ¹	Output Volts	Rated Current	Current Range	Output Power	Ripple & Noise ²	Line Regulation	Load Regulation	Voltage Tolerance ³	Efficiency
TF1500A12K	12 V	125 A	0-125 A	1500 W	150 mV pk-pk	± 1%	± 1%	± 2%	89%
TF1500A15K	15 V	100 A	0-100 A	1500 W	150 mV pk-pk	± 1%	± 1%	± 2%	90%
TF1500A24K	24 V	62.5 A	0-62.5 A	1500 W	240 mV pk-pk	± 1%	± 1%	± 2%	92%
TF1500A30K	30 V	50 A	0-50 A	1500 W	300 mV pk-pk	± 1%	± 1%	± 2%	92%
TF1500A36K	36 V	41.67 A	0-41.67 A	1500 W	360 mV pk-pk	± 1%	± 1%	± 2%	93%
TF1500A48K	48 V	31.37 A	0-31.37 A	1500 W	480 mV pk-pk	± 1%	± 1%	± 2%	92%
TF1500A60K	60 V	25 A	0-25 A	1500 W	600 mV pk-pk	± 1%	± 1%	± 2%	93%

Notes:

- Other output voltages available, consult factory.
- Ripple & noise are measured at 20 MHz of bandwidth by using a 12" twisted pair-wire terminated with a 0.1 uF & 47 uF parallel capacitor.
- Tolerance: includes setup time tolerance, line regulation and load regulation.
- All specifications are typical at 230 VAC, full load, at 25°C ambient unless noted.

LED STATUS INDICATOR

LED	LED Signal	Status
Solid (Green)		Power OK (Local Mode)
Solid (Orange)		Power OK (Remote Mode)
Slow Blink (Green)		Power Standby
Fast Blink (Red)		Over Voltage Protection (OVP)
Solid (Red)		Over Load Protection (OLP)
Intermittent Blink (Red)		Over Temperature Protection (OTP)
Intermittent Blink (Red)		Fan Failure
Interlace Blink (Red)		Power Failure

REMOTE ON/OFF

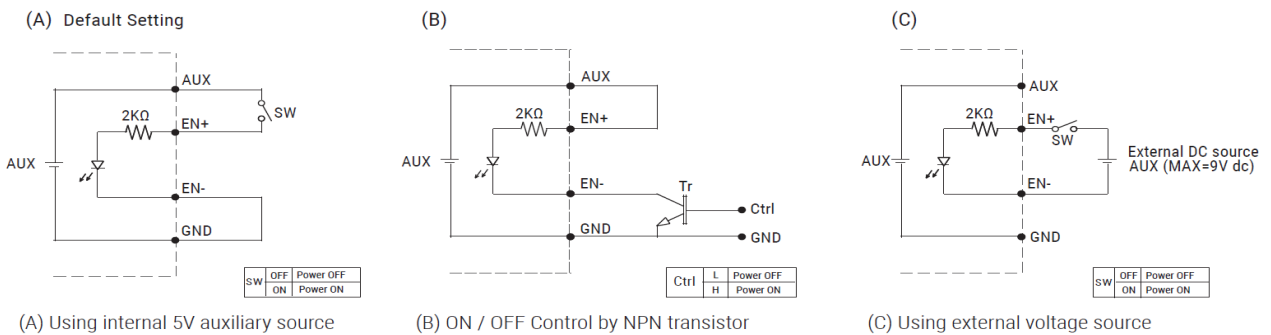

Note:

GND shown in above diagram is referring to the GND of CN2, not the Grounding from main power (NEG-).

DERATING CURVE

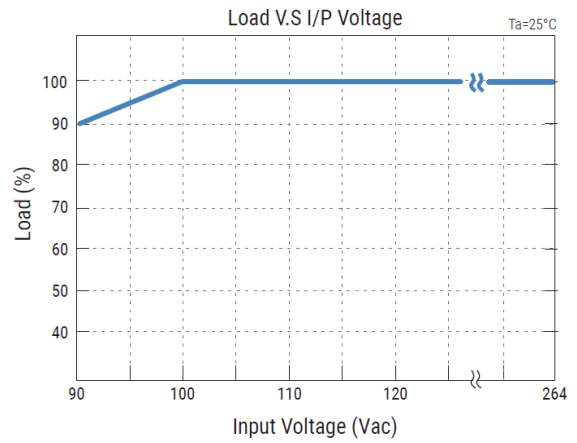
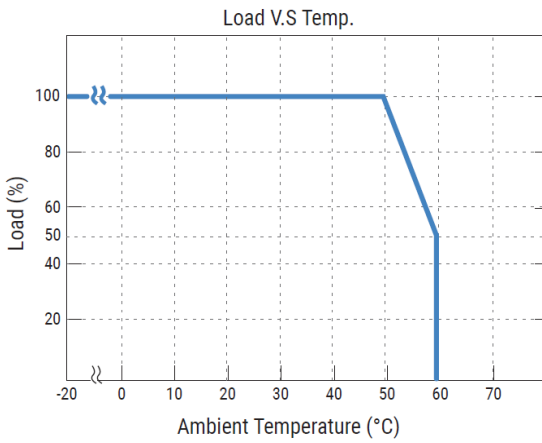

CMD vs Output Curve

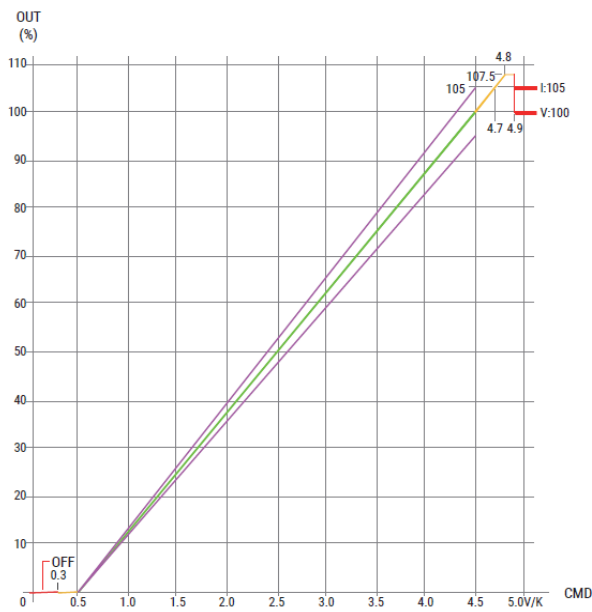

VCI vs OVP Curve

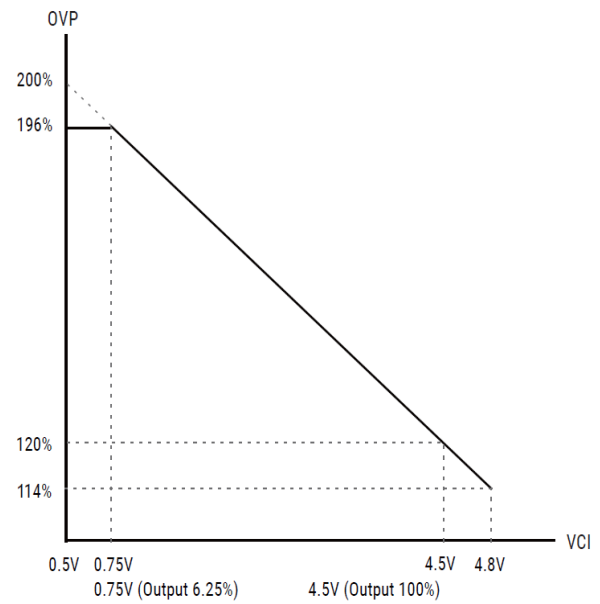

To ensure the power supply output voltage and current could be accurately adjusted, please make sure to adjust the output voltage and current > 10% vs. the rated voltage and current. (e.g. for a 24 V unit, please adjust the DC output voltage above 2.4 V to ensure accuracy; same applies to the output current)

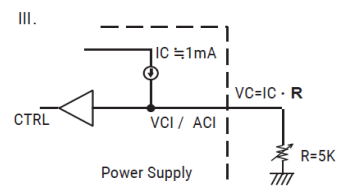
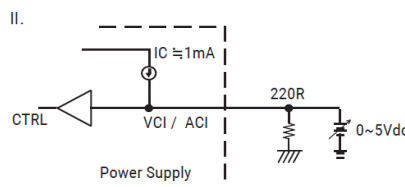
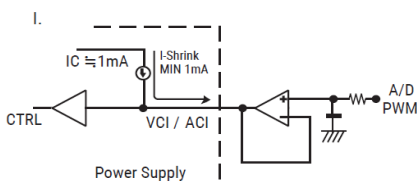
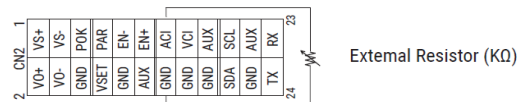
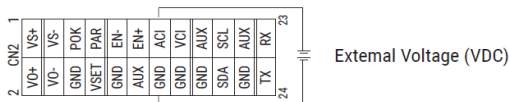

DERATING CURVE

Power OK Signal & Auxiliary Power Setting

The grounding of "AUX" power and P.0K signal should be connected to "GND" port. If "VO-" is connected as Grounding, make sure to short the GND and VO- ports.

Open drain signal low when PSU turns on. Max. P.0K sink current: 20 mA, Max, drain voltage: 40 V.

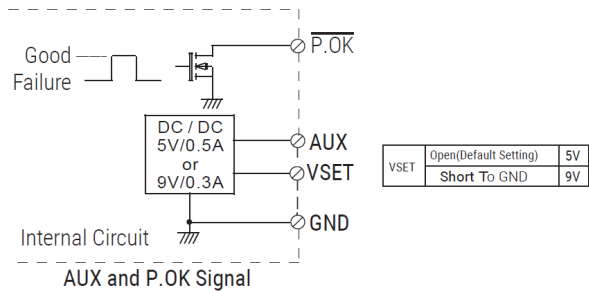

Note:
GND shown in above diagram is referring to the GND of CN2, not the Grounding from main power (NEG-).

Place an additional capacitor to have a better performance of auxiliary power operation.

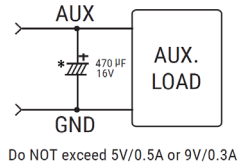

REMOTE SENSE

Remote Sense

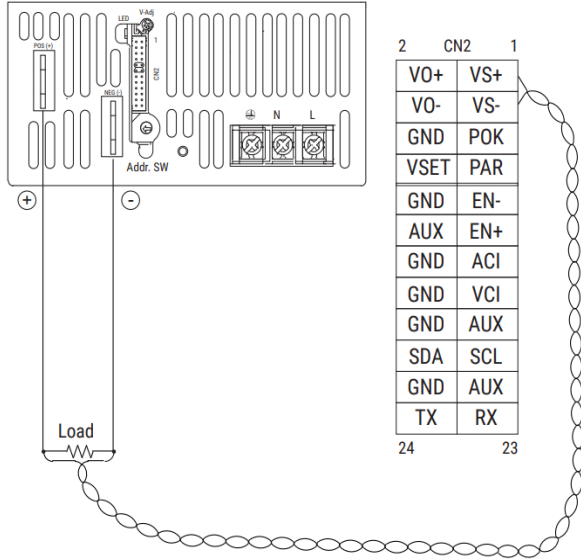

VS-, VS+ Compensation Voltage = <math><0.5V</math>

Local Sense (Default Setting)

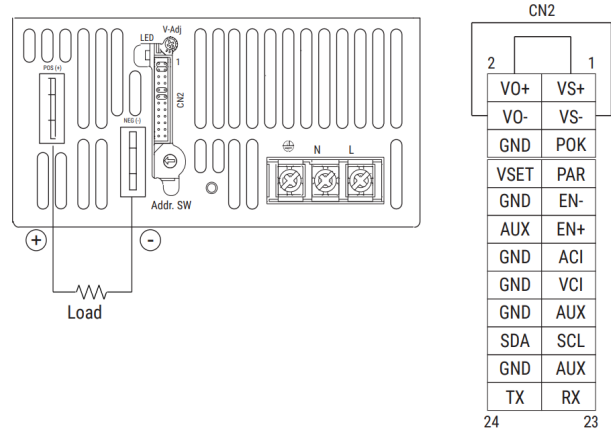

Current Sharing

Current Sharing with Remote Sensing (Parallel Connection)

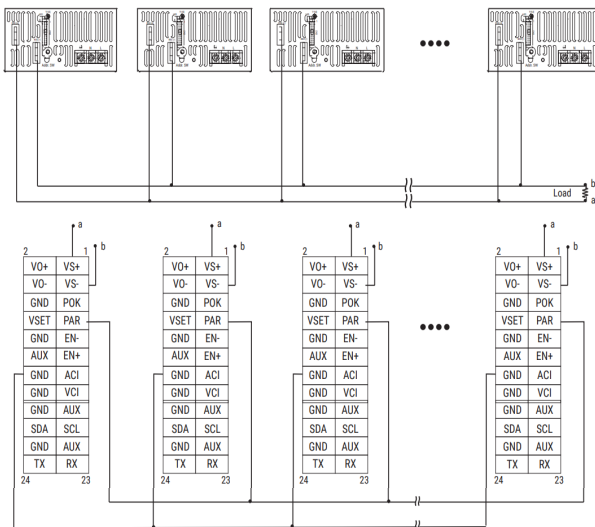

Connect PAR pins together for current sharing function

Current Sharing with Local Sensing

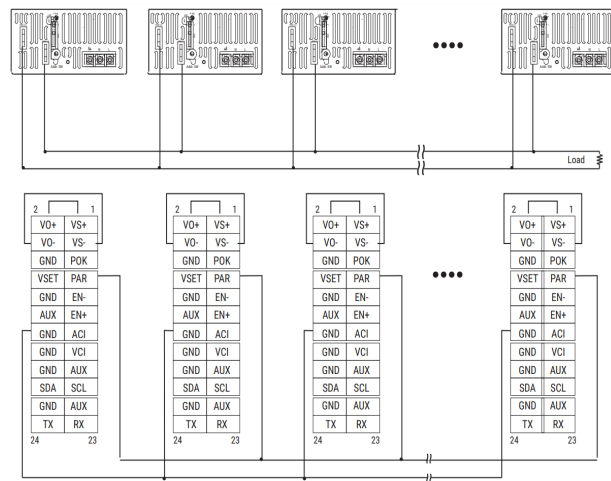

Connect PAR pins together for current sharing function

MOUNTING INSTRUCTIONS

Recommended Standard Mounting Configurations:

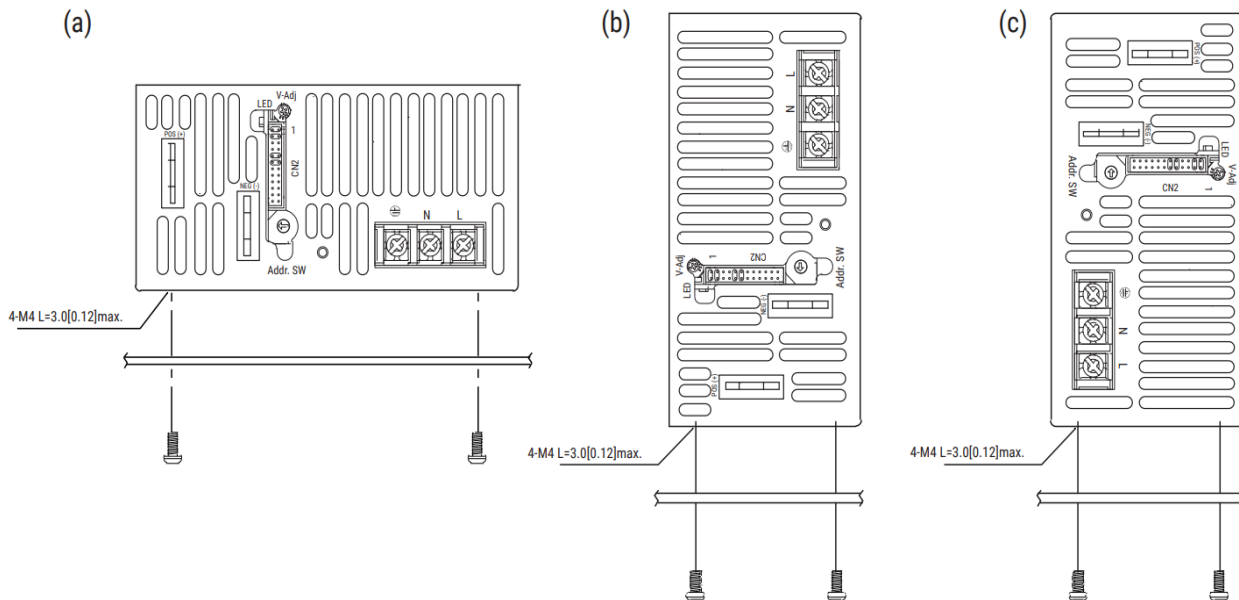

Notes:

1. Recommended screw length is measured from the power supply surface.
2. Ventilating holes on the front and back side panels should not be obstructed. Allow min. 50 mm space for air flow. See below.
3. Recommended torque of M4 mounting screws is 1.27 N · m (13.0 kgf · cm).

More than 50mm

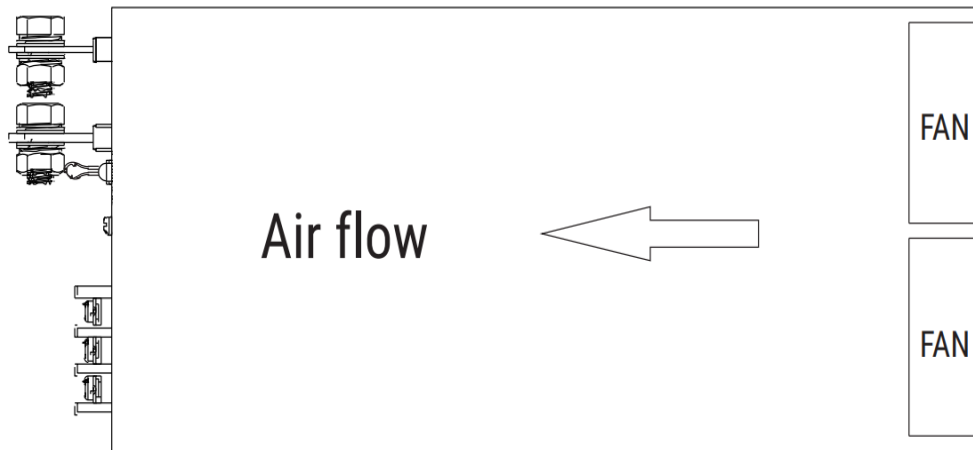

More than 50mm



Disclaimer: The information and specifications contained herein are believed to be correct at the time of publication. However, AE accepts no responsibility for consequences arising from reproduction errors or inaccuracies. Specifications are subject to change without notice.



For international contact information,
visit [advancedenergy.com](https://www.advancedenergy.com).

powersales@aei.com (Sales Support)
productsupport.ep@aei.com (Technical Support)
+1 888 412 7832

ABOUT ADVANCED ENERGY

Advanced Energy (AE) has devoted more than three decades to perfecting power for its global customers. AE designs and manufactures highly engineered, precision power conversion, measurement and control solutions for mission-critical applications and processes.

Our products enable customer innovation in complex applications for a wide range of industries including semiconductor equipment, industrial, manufacturing, telecommunications, data center computing, and medical. With deep applications know-how and responsive service and support across the globe, we build collaborative partnerships to meet rapid technological developments, propel growth for our customers, and innovate the future of power.

PRECISION | POWER | PERFORMANCE | TRUST

Specifications are subject to change without notice. Not responsible for errors or omissions. ©2023 Advanced Energy Industries, Inc. All rights reserved. Advanced Energy®, and AE® are U.S. trademarks of Advanced Energy Industries, Inc.